

*Full Length Research Paper*

# Grasp planning analysis and strategy modeling for underactuated multi-fingered robot hand using in fruits grasping

Li Shanjun<sup>1\*</sup>, Shuangji Yao<sup>2</sup>, Zhang Yanlin<sup>1\*</sup>, Meng liang<sup>1</sup> and Lu Zhen<sup>2</sup>

<sup>1</sup>College of Engineering, Huazhong Agricultural University, Wuhan P. R. China.

<sup>2</sup>School of Automation Science and Electrical Engineering, Beihang University, Beijing P. R. China.

Accepted 5 April, 2011

To solve the unfixed grasping tasks during the fruits picking and rating, grasping modeling is researched as the most important part of the robot hand solutions. A survey for grasping synthesis method with dexterous robot hand is presented in this paper. The difference of grasping characters is introduced between dexterous hand and underactuated hand. Especially, the feature of self-adaptive enveloping grasp achieved by underactuated finger mechanism is outlined, which has good performance in grasping unknown objects. In order to generate valid grasps for unknown target objects and apply in real-time control system for underactuated robot hand, a grasping strategy synthesis model for universal grasp tasks is proposed based on human knowledge analysis. It is composed by off-line neural networks training section and on-line compute section. Firstly, daily grasped objects are used to build a sample space by human experience. Then the discrete sample space is computed by fuzzy clustering method. The data is used to generate grasp decision scheme by rough set mixed artificial neural networks. An examination is simulated for grasp configurations choice of the underactuated robot hand with the aim to show the practical feasibility of the proposed grasp strategy.

**Key words:** Underactuated robot hand, grasp planning, neural network, fruits grasping.

## INTRODUCTION

China possesses the whole world's 21% fruit growing area, and with a total output of more than 180 million tons, but the fruit-picking mainly rely on human powers, since there's not any appropriate machinery in the market. The main reasons for the absence of the appropriate machinery in the market, is due to the technology requirements in fruit-picking process is very high, especially the grasping robot should be reliable and will not damage fruit. With the more and more prominent problems of labor costs rising and labor shortages, it's extremely imperative to adapt machinery in fruit-picking. and characteristics of a variety of fruits and vegetables picking robot's end-effectors, which put forward that under actuated multi-fingered hand is an ideal fruit and vegetable picking robot's general-purposed end-effectors; One of the most important part is to solve the robot hand's grasping problem, at the same time the robot

hand can also be used for picking fruit of different shape, and the after process treatment such fruit grading in different picking tasks. Targeting fruit grasping problem, Song et al. (2006) introduces the study result of some typical picking robot both in domestic and oversea, which indicate that the studying of picking robot not only has great practical value, but also has profound theoretical significance; Li et al. (2008) analyzes the studying status and characteristics of a variety of fruits and vegetables picking robot's end-effectors, which put forward that under actuated multi-fingered hand is an ideal fruit and vegetable picking robot's general-purposed end-effectors; Cai et al. (2009) targets the real time path planning problem of citrus picking robot in dynamic and unstructured environment, make use of the BL-PRM algorithm, have simulated test of citrus picking under both the condition of picking exposed and overlapped fruits; Yang et al. (2010) designs an apple picking's end-effectors, based on the flexible pneumatic actuator, which can grasp and hold well the apples with good flexibility; Yuan et al. (2009) transfers the apple-picking path's

\*Corresponding author. E-mail: [lishanjun@yahoo.cn](mailto:lishanjun@yahoo.cn).

planning problem into three dimensional “travel salesman problem”, combined the apple position characteristics obtained through image processing, put forward the improved ant colony algorithm based on the adaptive update pheromone of finite field. The core issue is grasp programming.

As multi-fingered robotic dexterous hand has been proposed since 70s last century, the design, analysis and control of such hands has become an active area of research. Many studies focus on the issues of strategy and planning for target objects grasp. It refers to some aspects such as grasping mode choice, grasping position planning for fingers and palm, contacting point selection, kinematic and torque computation for each joint, operation and stability. Researching works are undertaken from different views in order to analysis grasp planning and establish grasp strategy models. Geometry method is an initial solution to build grasp strategy model which is based on the theory of form-closure and force-closure. Nguyen (1988) presented a simple algorithm for directly constructing force-closure grasps based on the shape of the grasped object. An efficient algorithm for synthesizing grasp is reported for bounded polyhedral/polygonal objects (Mishra et al., 1987). Ponce and Sullivan (1997) addressed the problem of computing stable grasps of three-dimensional polyhedral objects. An algorithm for computing all placements of frictionless grasping point fingers is proposed (Stappen et al., 2000). The algorithm translated grasping problem into geometric searching problems. Thus, the solving process may be complex and mass computation.

A sufficient and necessary condition to achieve form-closure grasp is demonstrated for multi-fingered robot hand (Liu et al., 1999). An improved approach is reported by using a ray-shooting algorithm to test force-closure for 3D frictional grasp (Zheng and Qian, 2005). Optimum function is also used for grasp synthesis analysis for multi-fingered robot hand. First of all, there should be an evaluation function as the optimal criterion. The function is translated from some grasping capability items such as manipulating space, grasp forces and torque, grasp stability. The results for grasping parameter can be calculated when optimum criterion reach the maximum or minimum solution. A task-oriented quality measure is proposed for evaluating grasp by computing the minimum singular value for the grasping matrix (Li and Sastry, 1988). Stable grip and form-closure optimum problem is formulated and solved (Markenscoff and Papadimitriou, 1989). A unit contact forces for multi-finger grasp is researched (Kirkpatrick et al., 1992). An optimality criterion based on decoupled wrenches is presented (Mirtich and Canny, 1994), in which the algorithms for achieving force-closure grasps of 2-D and 3-D objects are developed. Two general optimality criteria that consider the total finger force and the maximum finger force are introduced and discussed (Ferrari and Canny, 1992). An approach is reported to quantify the effectiveness of compliant grasps and fixtures of an object; a stiffness

quality measure is defined and used as an optimal criterion (Lin, 2000).

A general algorithm, which is composed by two computing phases is presented (Zheng and Qian, 2005) for optimum dynamic force distribution in multi-fingered grasping. The considerations based on optimum function for grasp synthesis are focused on optimum evaluation. However, it is complex to provide a formulation and quantification evaluation function in a multi-contact grasp system. In addition, the optimality iterative process also needs mass computation to converge, thus it is difficult to apply in a real time control system. In fact, the target objects are multivariable depending on different shapes, grasping tasks and environment. It is complicated to translate and formulate a mathematical model by physical analyzing. Thus the hand system usually can not be programmed for universal grasp tasks before grasping operation. In this paper, a new grasp planning analysis based on human knowledge is proposed for modeling grasp strategy for underactuated multi-fingered robot hand. The underactuated finger mechanism is able to perform a human-like grasping operation and it has ability of passive compliance self-adaptation to grasp objects of a large variety in size and shape. In particular, the proposed grasp strategy model is built by rough set mixed artificial neural networks.

The specific characters of the grasp strategy model are rapid calculation speed and high accuracy rate in grasp choice taxonomy and can be used for universal grasp tasks.

## **GRASP STRATEGY BASED ON HUMAN KNOWLEDGE**

A human hand can grasp one target object with different types of configurations. That would lead to different grasping stability and dexterity. The rule of grasp configuration choice for a human is daily experience or intelligence consideration before grasp action. For example, a human hand can use two or three finger tips to pinch a hammer handle, but it is easy to slide off. However, it will be stable if the whole hand fingers and palm envelope it together. Thus, it can be concluded that human experience and artificial intelligence is the basic for a robot hand grasp planning and grasp strategy modeling based on human knowledge. The grasp strategy based on human knowledge for multi-fingered robot hand grasp synthesis is developed in recent years. Some simplification and assumptions is proposed (Cutkosky, 1989), which are applied in manufacturing environment for robotic hands grasp tasks. A knowledge-based approach for robotic hand grasping unknown objects is described (Stansfield, 1991). A compact set of heuristics expert system is used to generate valid grasps for the unknown objects with a desired configuration. The issue of developing grasping controller composed by a knowledge framework and a pre-imaging system is

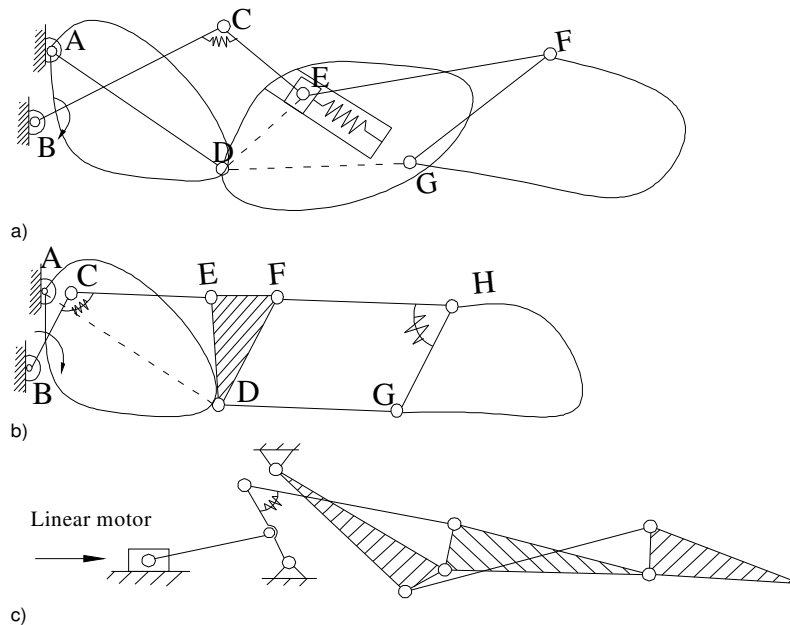

**Figure 1.** Three kinds of finger mechanisms for underactuated robot hand.

discussed (Coelho and Grupen, 1994).

A grasp synthesis algorithm is introduced (Pollard, 1996). The expert system can generalize application instances by many prepared grasp prototypes. A grasp strategy can be generated for a specific grasp task. The relationship among grasp task, object geometry and grasp choice are analyzed and reported (Cutkosky and Wright, 1986). In retrospect, a grasping strategy synthesis model is used to establish the relationship between target objects and grasp configuration choice. The grasp synthesis based on human knowledge can be carried out when a target object's characteristics of shape and grasp task is known. It would be applied in a real-time control system with three necessary characters:

- Robot hands can achieve some stable grasp configurations.
- The experiences of human knowledge can be studied as an artificial intelligence to build a grasp strategy synthesis model.
- The grasp strategy synthesis model has the character of rapid calculation speed.

### GRASP TAXONOMY FOR UNDERACTUATED MULTI-FINGERED ROBOT HAND

A dexterous robot hand has the same number with actuators and DOFs (degree of freedoms). The torque or rotation motion of each joint can be controlled. Underactuated finger mechanism is designed with a reduced number of DOFs and actuators. It can be built with low-cost and easy-operation features for applications

in robot hand. In addition, an underactuated finger mechanism in robot hand can perform stable grasps by using enveloped configuration. Ceccarelli et al. (2006) has presented design considerations and structure scheme of finger mechanism for underactuated grasp. Some linkage underactuated finger mechanisms are proposed (Yao et al., 2008) as shown in Figure 1. The design problems and grasp simulation was undertaken (Yao et al., 2008) for these mechanisms. It can be shown from the grasp simulation that the proposed underactuated robot finger mechanisms have the features of self-adaptive and enveloping grasp with different shapes and size objects, in spite of the objects' characters are uncertain and complicated to describe in formulation, as shown in Figure 2.

The joint motion limitation can be designed in each phalanx. The finger mechanisms can transmit torque from the finger root when the joints reach limit position. It is used to ensure the pinch operation with the finger tips. Thus, underactuated robot finger mechanisms can be put into practice as an approach to due with the unknown universal grasps tasks. As shown in Figure 2, fingers 1 and 2 are symmetrically assembled in the palm, a straight-teeth gear system is located under the palm. Finger 3 is thumb, whose position is fixed. The position of fingers 1 and 2 can be changed within a circular track around the palm central. The prototype of the proposed underactuated multi-fingered robot hand is shown in Figure 4. The hand system is composed by three fingers. It can be concluded from Figures 3 and 4 that the proposed hand system has three possible working positions to achieve different grasp configurations, which are listed and explained.

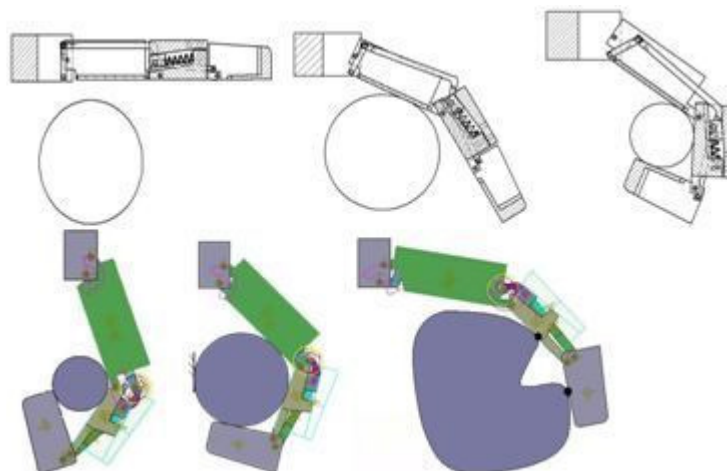

**Figure 2.** Grasp simulation of underactuated robot finger with the mechanism in Figure 1a.

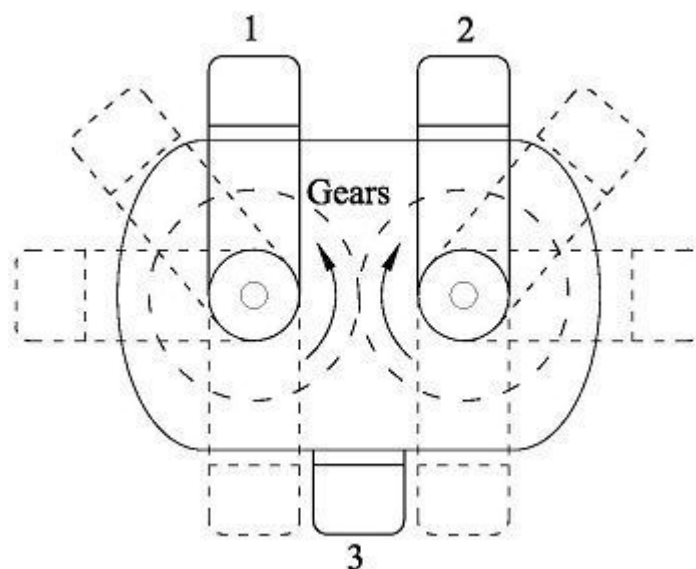

**Figure 3.** Gear system for finger positions adjusting in palm.

#### **Position 1**

Fingers 2 and 3 opposite with finger 1, as shown in Figure 4a.

#### **Position 2**

Three fingers centripetal, as shown in Figure 4b.

#### **Position 3**

Fingers 2 and 3 parallel, finger 1 is free, as shown in Figure 4c.

#### **Position 4**

Three fingers parallel in one side, as shown in Figure 4d. Thus, there are six grasp configurations which are described in Figure 5. The types of the grasp configurations are associated with the common situations for human grasp tasks in daily life. They can be explained in details as:

#### **Configuration 1**

Three finger parallel pinch, shown in Figure 5a. Fingers 2 and 3 are parallel and finger 1 located on the other side

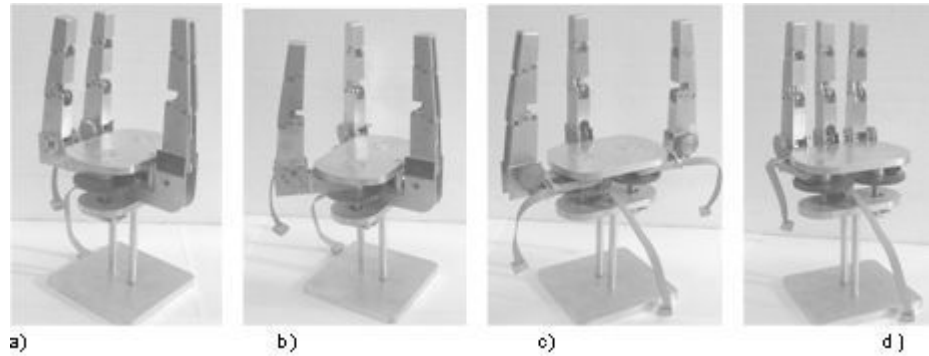

**Figure 4.** The proposed hand prototype with different finger positions: a) Fingers 2 and 3 opposite with finger 1; b) three fingers centripetal; c) fingers 2 and 3 parallel, finger 1 is free; d) three fingers parallel in one side.

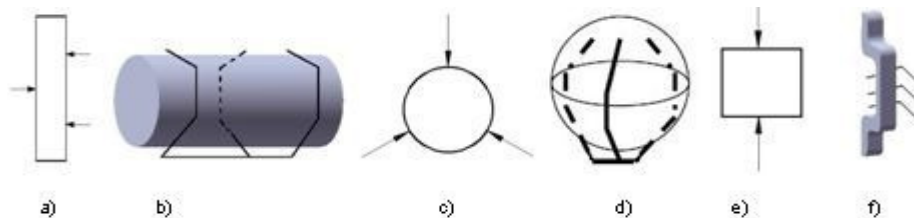

**Figure 5.** Grasp configurations: a) three fingers parallel pinch; b) three fingers cylindrical envelop; c) three fingers centripetal pinch; d) three fingers centripetal envelop; e) two fingers parallel pinch; f) three fingers parallel pull.

of the target object. Finger tips are used to pinch small long objects. This configuration is derived from position 1. For example, pinch pencil to write.

### **Configuration 2**

Three fingers parallel envelop, shown as Figure 5b). Fingers 2 and 3 are parallel and finger 1 located on the other side to envelop big cylinder objects, while finger phalanxes are all contact with object. This configuration is also derived from position 1. For example, envelop grasp a bottle of beer.

### **Configuration 3**

Three fingers centripetal pinch, shown in Figure 5c). Fingers 1, 2 and 3 are located central symmetric on the palm. Three finger tips are used to pinch small spherical objects or small regular polyhedron objects. This configuration is derived from position 2. For example, grasp a golf ball.

### **Configuration 4**

Three fingers centripetal envelop, as shown in Figure 5d).

Fingers 1, 2 and 3 are located central symmetric on the palm to envelop some spherical objects while finger phalanxes are all contact with object. This configuration is also derived from position 2. For example, grasp an apple.

### **Configuration 5**

Two fingers centripetal pinch, shown as Figure 5e). Fingers 2 and 3 pinch very small object and finger 1 is free. This configuration is derived from position 3. For example, grasp a pill or a coin.

### **Configuration 6**

Three fingers parallel pull in one side, shown as Figure 5f). Three fingers are parallel at the same side of the object. Finger tips are used to pull small long objects. This configuration is derived from position 4. For example, pull handles to open a door. The purpose of taxonomy for the grasp configurations is used to describe the grasp choice for grasp planning and the strategy modeling. The relationship between grasp choice and target objects character on shape and size will be built based on the taxonomy. It should be clarified that the grasp configurations taxonomy in this paper is applied for

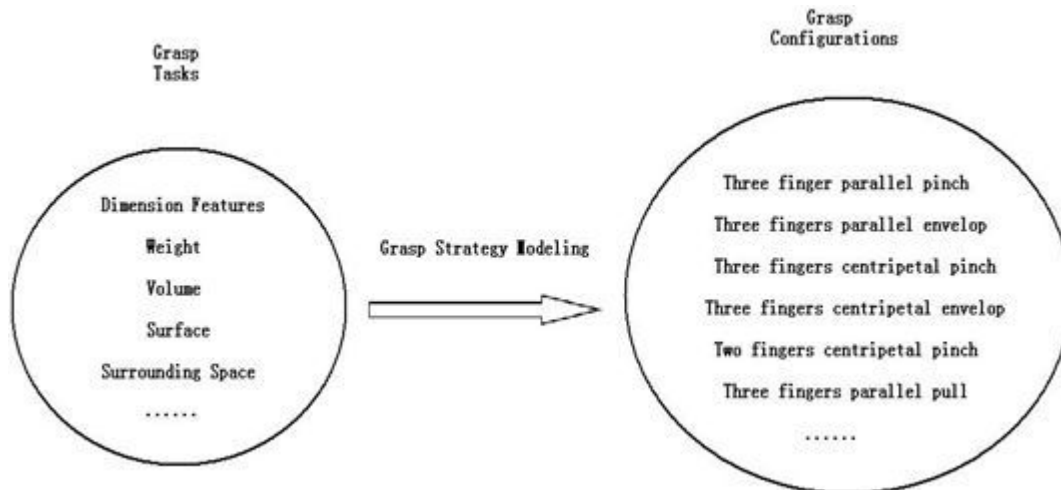

Figure 6. Gras strategy modeling for different tasks.

the proposed underactuated multi-fingered robot hand. Because the grasp configuration is decided by the finger position and the underactuated finger mechanism as designed.

## GRASP PLANNING MODELING BASED ON ARTIFICIAL NEURAL NETWORKS

### Modeling algorithm with human grasp knowledge

A real human hand can grasp a wide range of objects stably because of its experience and skill in adapting object shape and size. Intelligence human hand can consider their experience to generate a suitable grasp strategy according to the objects, environment and tasks. Three algorithms for model grasp strategy have been mentioned (Zhang et al., 2007). They are Gaussian mixture model, support vector machine and artificial neural networks, respectively. The advantages and weaknesses of these modeling algorithms have also been discussed. Rough set theory was firstly presented by Skowron and Rauszer (1982), and can be applied for information processing. It has been proven that rough set theory is an effective approach to analyze imprecise, confused or fragmented data sets. Thus, rough set is considered as a mathematical method for data reasoning, which can be used in the field of knowledge acquisition, decision analysis, forecasting, expert systems, probability estimation and knowledge discovery. Because the complemented relative between rough set theory and other mathematical method such as artificial neural networks or fuzzy theory. It has possibility to mix the rough set theory with artificial neural networks or fuzzy set theory and generate a new analysis algorithm artificial neural networks algorithm is provided in this paper to solve the uncertainty decision analysis for grasp strategy

modeling of the underactuated robot hand. The grasp strategy modeling can be easily described as Figure 6.

The grasp strategy modeling procedure is shown in Figure 7. It is composed by three sections, which are data preprocess section, rough set mixed artificial neural networks section and motor control section, respectively. The first section of the modeling procedure is to describe and classify objects into different types by taxonomy. The proposed rough set method is applied to process attribute parameters for objects. First of all, some shape and size characteristics of the sample objects should be obtained. Then the attributes concerned with obtained size and shapes characteristics is extracted from the sample objects. Then, the extracted attribute parameters are classified into different types and each type of the object has the similar shape and size. Fuzzy clustering method (FCM) is used as a taxonomy which can class assignment continuous data by their features. The second section of the modeling procedure is to train grasp strategy networks off-line and generate grasp strategy networks on-line. Each type of objects classified in section one represents a kind of object which corresponds to a grasp strategy. The grasp strategy decision scheme for all types of sample objects can be built by considering human experience and knowledge. The generated scheme will be used for artificial neural networks training. However, the scheme contains the whole characteristics of the sample objects, the mass data will result the neural networks become complicated and low efficiency. Thus, there should be a simplification calculation by using rough set analysis method to get a brief grasp strategy scheme. Then the simplified scheme can be trained by off-line neural networks.

In this paper three neural networks are proposed with the aim to show training effect. They are PB neural networks, RBF neural networks and possibility neural (Walczak and Massart, 1999). Thus, a rough set mixed

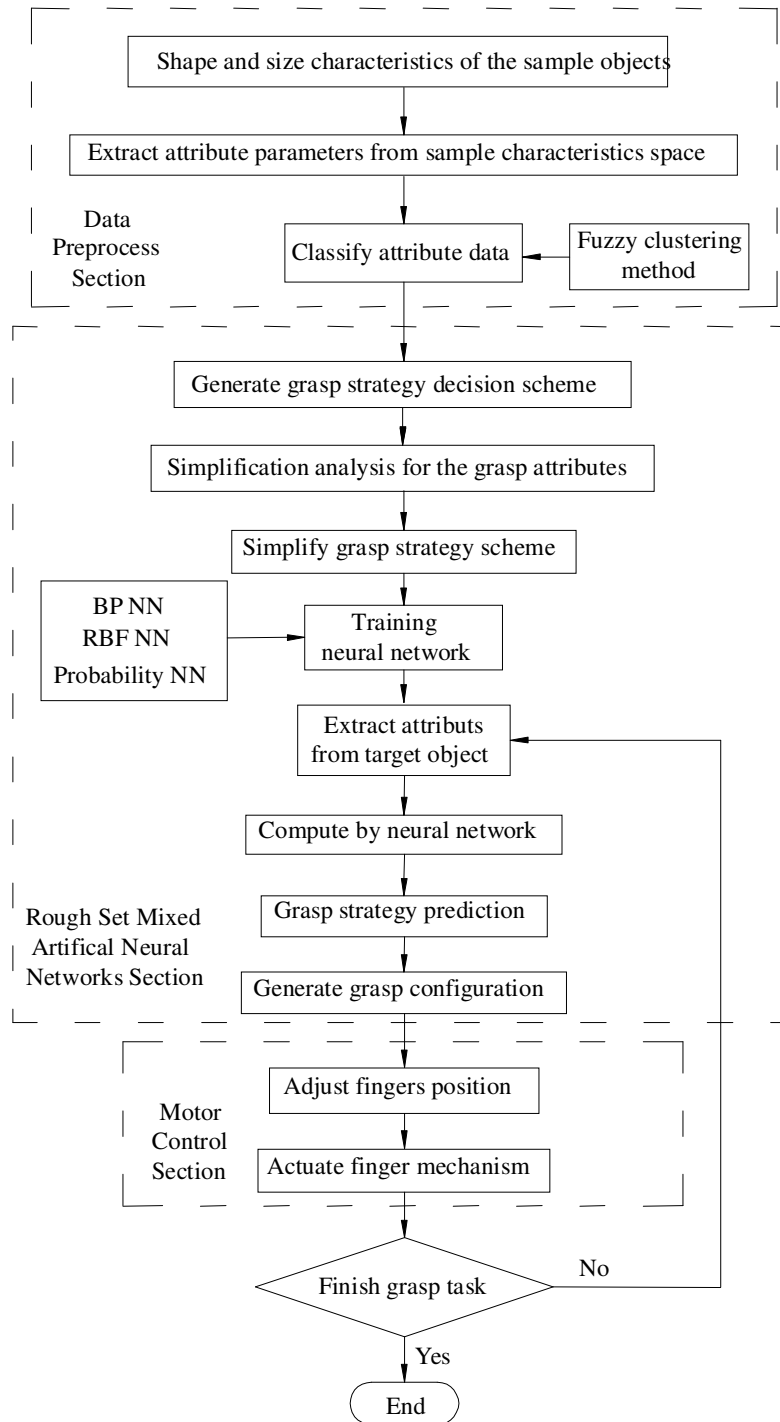

**Figure 7.** A flowchart for the proposed grasp strategy modeling procedure.

networks, respectively. When a grasp task is ordered, the attributes will be extracted from target object and computed as independent variable for the on-line neural networks. Then a grasp strategy will generate to predicate the grasp configuration for the target object in a real-control system. The function of last section is to

control and actuate motors in the hand system. The three fingers will be adjusted into appropriate positions at first after a grasp configuration generated. Then the motors actuate finger mechanisms to grasp object and complete the grasp task. If the task can not be finished, the system will extract attribute parameters again from the target

object and generate a new grasp strategy.

### Objects description and data preprocess

A space which contains a large number of target objects is built and defined as objects space. The objects space is composed by 251 common instances in daily grasp task for human life, and can be denoted as  $U$ , and each of the object instance can be defined as  $u_i$  ( $i = 1, \dots, 251$ ). The attribute parameters of the sample objects are extracted from five aspects which composed an attribute parameters space. These characteristics will decide the grasp strategy and can be obtained by robot vision recognition system. It also can be obtained by other methods, but we only focus on the issue of grasp strategy modeling in this paper. The five attribute parameters are concerned with size, shape, weight, volume, revolving body and surrounding space. Thus, an attribute space can be defined as  $A$ , it includes five attribute parameters for the 251 common instances, which can be expressed as  $a_i$  ( $i = 1, \dots, 5$ ). First of all, each instance  $U_i$  was approximately described as a cube. The cube is decided by three parameters which are length, width and height. Thus, the five attribute parameters can be described as:

- i)  $a_1$ : The three dimension features of the approximate cube;
- ii)  $a_2$ : The weight of the sample objects;
- iii)  $a_3$ : The volume of the sample objects;
- iv)  $a_4$ : If the sample objects have rotative surface or not;
- v)  $a_5$ : If the sample objects have enough surrounding space or not.

Because  $a_1$ ,  $a_2$  and  $a_3$  are continuous data which can not be processed in the rough set mixed neural networks. There should be a preprocess operation to divide them into different types by their features. Thus, a fuzzy clustering method is used for classification assignment. Fuzzy clustering method is used to classify  $a_1$  into three types by considering the three dimension variables,  $a_2$  and  $a_3$  are also classified in the same way into three types, respectively. The parameters of  $a_4$  and  $a_5$  are discontinuous data which will show the possibility for envelop grasp or pull. Thus, these classified attribute parameters can be transformed into digital format and described as:

- i)  $a_1$ : (0, 1, 2) to express (slender, medium and flat) attribute for an object according to three dimensions.
- ii)  $a_2$ : (0, 1, 2) to express (heavy, medium and light) attribute for an object according to weight;
- iii)  $a_3$ : (0, 1, 2) to express (large, medium and small) attribute for an object according to volume;
- iv)  $a_4$ : (0, 1) to express (non-rotative and rotative) attribute for an object according to its body surface;
- v)  $a_5$ : (0, 1) to express (without and with) surrounding

space for an object. For example, an object located in corner usually has no surrounding space.

### Generate and simplify grasp strategy decision scheme

There should be a grasp decision space which can describe final grasp configurations in the strategy modeling algorithm. Grasp decision space can be denoted as  $D$ . Because the proposed robot hand has six grasp configurations, the grasp decision space contains six parameters which are defined as  $d_i$  ( $i = 1, \dots, 6$ ). In order to compute in the rough set mixed neural networks, each of the decision should be converted into digital format as:

- i)  $d_1 = 1$ : Three finger parallel pinch;
- ii)  $d_2 = 2$ : Three fingers parallel envelop;
- iii)  $d_3 = 3$ : Three fingers centripetal pinch;
- iv)  $d_4 = 4$ : Three fingers centripetal envelop;
- v)  $d_5 = 5$ : Two fingers centripetal pinch;
- vi)  $d_6 = 6$ : Three fingers parallel pull.

Then the objects space  $U$  is separated into two parts which are  $U_1$  and  $U_2$ .  $U_1$  contains 200 sample objects,  $U_1 = (u_1, \dots, u_{200})$  which is used for neural networks training and to generate grasp decision scheme;  $U_2$  contains the other 51 sample objects of the objects space  $U$ ,  $U_2 = (u_{201}, \dots, u_{251})$  which is used for the grasp strategy examination with the neural networks. The grasp decision scheme for 200 sample objects  $u_i$  ( $i = 1, \dots, 200$ ) can be built by considering human experience and knowledge, each of them contains 6 attribute parameters  $a_i$  ( $i = 1, \dots, 6$ ) and a decision parameter  $d_i$ . Because of the mass of data, the neural networks will be complicated and the calculation efficiency will be reduced. Thus, redundant samples which have the same attribute parameters and grasp decision should be combined and can be considered as a type of target object. The simplified decision scheme is composed by 34 types of samples ( $u_1, \dots, u_{34}$ ) which include most common objects in daily life and is listed in Table 1.

The obtained simplified grasp decision scheme in Table 1 can be far-simplified with the aim to delete the redundant attribute parameters according to the rough set theory. Thus, an algorithm is proposed which can keep each grasp strategy independent by searching and removing some redundant attribute parameters. The brief grasp decision scheme is listed in Table 2, in which the minimum form of the attribute space is obtained as ( $a_1, a_2, a_3, a_5$ ) and the redundant attribute parameter  $a_4$  has been removed. Comparing with Table 1, the sample attribute parameters in far-simplified decision scheme are less than before, but the strategy decisions are not affected. Some of the redundant strategies are combined, such as ( $u_4, u_{28}$ ), ( $u_6, u_{26}$ ), ( $u_7, u_{10}, u_{22}$ ), ( $u_{13}, u_{25}$ ) and ( $u_{15}$ ,



**Table 1.** Simplified grasp strategy decision scheme.

Samples ( $u_i$ )	Attribute parameter					Decision ( $d_i$ )
	$a_1$	$a_2$	$a_3$	$a_4$	$a_5$	
1	0	1	2	1	0	4
2	0	0	0	0	0	1
3	0	1	1	0	0	3
4	1	1	0	0	0	2
5	1	2	0	1	0	5
6	0	2	0	1	0	4
7	2	0	2	1	1	4
8	1	0	2	0	1	1
9	0	0	2	0	0	3
10	2	1	2	0	0	4
11	0	0	1	0	0	1
12	2	1	0	0	0	4
13	1	2	1	0	0	5
14	0	0	2	0	1	3
15	1	1	0	1	0	2
16	1	0	1	0	0	1
17	0	1	0	0	0	3
18	0	1	2	0	1	4
19	0	2	2	0	0	4
20	1	2	2	1	0	5
21	2	0	1	0	1	6
22	1	2	0	1	1	5
23	0	2	0	0	0	4
24	2	2	1	0	0	4
25	0	0	1	0	1	6
26	0	1	1	1	0	3
27	1	0	0	0	0	1
28	0	1	0	0	0	3
29	1	1	1	0	0	5
30	2	0	1	0	0	3
31	2	0	0	0	1	6
32	1	0	1	0	1	1
33	1	0	1	0	0	1
34	0	2	1	0	0	4

$u_{17}$ ). Table 2 is much brief and suitable for neural networks training.

### Neural networks training and examination

The obtained far-simplified grasp strategy scheme can be used for artificial neural networks training. In this paper, three neural networks methods are presented which are BP neural networks, RBF neural networks and possibility neural networks, respectively. The model of BP networks is 3-layer feed forward neural network. Hidden layer is

composed by 7 neurons and hyperbolic tangent function. Conjugate gradient algorithm is applied for networks training. The function in RBF neural networks is designed by using Gaussian function and the neurons can be added automatically by considering the mean-squared error of the networks' output. The training work will be finished until the output error meets requirement. Possibility neural networks were appropriate method applied in taxonomy as reported in 0. It has the feature of fast calculate speed and better generalization performance. Thus, it can be used as a method for the grasp strategy modeling. The far-simplified grasp strategy

**Table 2.** Far-simplified grasp strategy decision scheme.

Samples ( $u_i$ )	Attribute parameter				Decision ( $d_i$ )
	$a_1$	$a_2$	$a_3$	$a_5$	
1	0	1	2	0	4
2	0	0	0	0	1
3, 26	0	1	1	0	3
4, 15	1	1	0	0	2
5	1	2	0	0	5
6, 23	0	2	0	0	4
7	2	0	2	1	4
8	1	0	2	1	1
9	0	0	2	0	3
10	2	1	2	0	4
11	0	0	1	0	1
12	2	1	0	0	4
13	1	2	1	0	5
14	0	0	2	1	3
16, 32, 33	1	0	1	1	1
17, 28	0	1	0	0	3
18	0	1	2	1	4
19	0	2	2	0	4
20	1	2	2	0	5
21	2	0	1	1	6
22	1	2	0	1	5
24	2	2	1	0	4
25	0	0	1	1	6
27	1	0	0	0	1
29	1	1	1	0	5
30	2	0	1	0	3
31	2	0	0	1	6
34	0	2	1	0	4

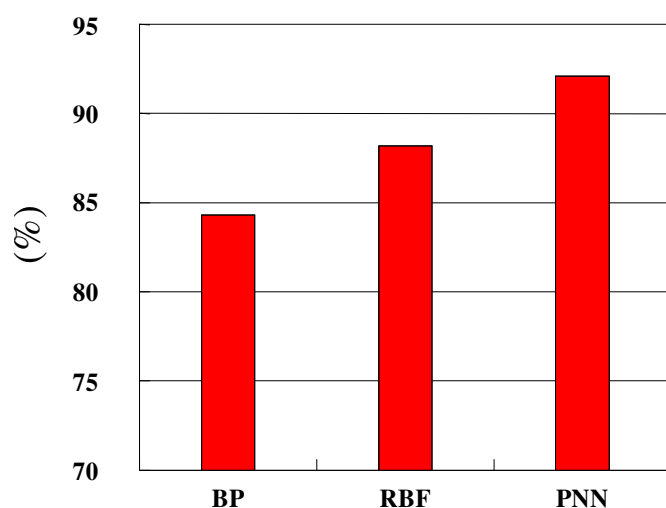
**Figure 8.** Computational results comparison of the three rough set mixed artificial neural networks.

decision listed in Table 2 is used as sample for the rough set mixed neural networks training. Then, the attribute parameters in the other object space  $U_2$  can be extracted. The compute results used for examination of the proposed algorithm by comparing with the grasp strategy decision scheme in Table 2. The computation result of the three rough set mixed neural networks is illustrated in Figure 8 and Table 3.

As shown in Figure 8 the proposed grasp strategy modeling based on three types of rough set mixed neural networks have a good computation results, the accuracy rate are all higher than 84%. Especially the modeling based on rough set mixed possibility neural networks, which perform the highest computational accuracy rate at 92.1%. The BP networks and RBF networks need to set the study parameters for training but the parameters setting is confused and should be attempted from engineering point. The possibility neural networks can acquire high accuracy rate and direct expression, while

**Table 3.** Results of grasp strategy based on rough set mixed neural networks (number in colored background means a fail compute result).

Object space ( $U_2$ )	Attribute parameter				Decision ( $d_i$ )	Results of rough set mixed networks		
	$a_1$	$a_2$	$a_3$	$a_5$		BP	RBF	PNN
201	2	0	2	1	4	3.9982	4	4
202	2	0	1	0	3	3.0025	3	3
203	0	1	1	0	3	2.9416	3	3
204	0	1	1	0	4	3.9416	4	4
205	2	1	0	0	4	3.995	4	4
206	1	0	2	1	1	1.0096	1	1
207	1	2	0	0	5	5.285	5	5
208	2	1	0	1	4	1.3385	2.8464	4
209	2	2	0	1	4	2.3588	4.0768	4
210	1	2	0	1	5	5.0096	5	5
211	1	1	1	0	5	4.3467	5	5
212	2	0	1	1	6	6.0036	6	6
213	1	0	1	1	1	0.9973	1	1
214	2	1	1	0	5	5.2134	4.7967	4
215	0	0	0	1	6	6.3847	5.9909	6
216	2	1	2	0	4	4.0014	4	4
217	0	0	1	0	1	1.3245	1	1
218	0	0	0	0	1	1.0134	1	1
219	1	0	0	0	1	1.0069	1	1
220	1	2	0	1	5	5.0096	5	5
221	0	2	1	0	4	4.0327	4	4
222	0	0	1	1	6	5.9951	6	6
223	2	2	1	0	4	4.2964	4	4
224	1	1	0	0	2	2.0021	2	2
225	2	0	0	1	6	5.9926	6	6
226	1	1	1	1	5	2.7281	3.192	5
227	0	0	1	0	1	1.3245	1	1
228	0	0	2	0	3	3.0316	3	3
229	0	1	2	0	4	3.8872	4	4
230	2	0	0	1	6	5.9926	6	6
231	2	0	1	1	6	6.0036	6	6
232	0	0	2	1	3	3.0044	3	3
233	0	1	2	1	4	3.8875	4	4
234	1	1	0	1	2	0.9496	2.5323	5
235	0	2	0	0	4	4.0307	4	4
236	1	1	0	0	2	2.0021	2	2
237	0	1	1	1	4	3.8344	3.0619	4
238	1	2	2	0	5	4.9934	5	5
239	2	0	1	0	3	3.0025	3	3
240	0	0	0	0	1	1.0134	1	1
241	1	2	1	0	5	5.3594	5	5
242	1	0	1	1	1	0.9973	1	1
243	2	1	0	0	4	3.995	4	4
244	0	1	0	0	3	2.6547	3	3
245	0	1	0	1	6	4.1483	2.931	3
246	0	2	2	0	4	3.8978	4	4
247	2	2	0	0	4	2.7543	4.6469	4
248	0	2	0	1	4	5.2734	3.8458	5
249	0	2	1	1	4	3.9017	3.681	4

Table 3. Contd.

250	0	0	1	0	1	1.3245	1	1
251	1	0	0	0	1	1.0069	1	1

only trained one time. Thus, rough set mixed artificial neural networks can be used as a suitable algorithm for grasp strategy modeling. It should be indicated that the proposed rough set method simplified the grasp strategy decision scheme which lead to a brief structure of networks. However, it does not mean that the omitted attribute parameter is not considered in the modeling process. It takes no effect for the strategy modeling because the omitted attribute parameter is redundant in the scheme. The underactuated finger mechanism robot hand performs preferable feature for passive compliance to envelop grasp behavior. The three fingered hand can grasp different object with the mentioned grasp configurations by suitable grasp strategy planning.

## CONCLUSIONS

In order to solve the grasp programming problem of robot hands during the fruit picking and grading process, the following study has been made. In this paper, the methods of grasp synthesis planning are summarized. A multi-fingered robot hand with underactuated mechanism is presented, which has the feature of self-adaptive enveloping grasp and can be used for uncertainty tasks to grasp unknown object. A grasp strategy modeling method is proposed with the purpose of applying in real-time control system. The modeling algorithm is based on human experience and knowledge by using rough set mixed neural networks. A case of examination shows the accuracy rate grasp strategy model are higher than 84%. Especially the algorithm based on rough set mixed possibility neural networks takes accuracy rate at 90.2%, which shows the practical feasibility of the proposed grasp strategy modeling method.

## ACKNOWLEDGEMENT

Part of this work was financially supported by the modern agricultural (citrus) industry technical system scientist position, public sectors (agriculture) scientific research special funds project (200903023).

## REFERENCES

- Song J, Zhang T, Xu L (2006). Research Actuality and Prospect of Picking Robot for Fruits and Vegetables. *Trans. Chinese Soc. Agric. Mach.*, 37(5): 158-162 (in Chinese).
- Qinchuan Li, Ting Hu, Chuanyu W (2008). Review of End-effectors in Fruit and Vegetable Harvesting Robot [J]. *Trans. Chinese Soc. Agric. Mach.*, 39(3): 175-179 (in Chinese).

- Cai J, Wang F, Qiang L (2009). Real-time path planning for citrus picking robot based on SBL-PRM[J]. *Trans. CSAE*, 25(6): 158-162(in Chinese).
- Yang Q, Jin Y, Qian S (2010). Research on End-effector of Apple Picking Based on New Flexible Pneumatic Actuator [J]. *Trans. Chinese Soc. Agric. Mach.*, 41(9): 154-158 (in Chinese).
- Yuan Y, Zhang X, Hu X (2009). Algorithm for optimization of apple harvesting path and simulation [J]. *Trans. CSAE*, 25(4): 141-144 (in Chinese).
- Nguyen VD (1988). Constructing Force-closure Grasps. *Int. J. Robotics Res.*, 7(3): 3-6.
- Mishra B, Schwartz JT, Sharir M (1987). On the Existence and Synthesis of Multi finger Positive Grips. *Algorithmica*, 12 (4): 541-558.
- Ponce J, Sullivan S (1997). On computing four finger equilibrium and force close grasps of polyhedral objects. *Int. J. Robotics Res.*, 16(1): 11-35.
- Stappen AFV, Wentink C, Overmars MH (2000). Computing Immobilizing Grasps of Polygonal Parts. *International J. Robotics Res.*, 19(5): 467-479.
- Liu Y, Ding D, Wang S (1999). Towards Construction of 3D Frictional Form-closure Grasps: A Formulation. *IEEE International Conference on Intelligent Robots and Systems*, Detroit, 1: 279-284.
- Zheng Y, Qian H (2005). Simplification of the ray-shooting based algorithm for 3-D force-closure test. *IEEE Trans. Robotics*, 21(3): 470-473.
- Li Z, Sastry S (1988). Task Oriented Optimal Grasping by Multi-fingered Robot Hands. *IEEE Trans. Robotics Automation*, 4: 32-44.
- Markenscoff X, Papadimitriou CH (1989). Optimum Grip of a Polygon. *Int. J. Robot Res.*, 8(2): 17-29.
- Kirkpatrick D, Mishra B, Yap CK (1992). Quantitative Steinitz's Theorems with Applications to Multi-fingered Grasping. *Discrete Comput. Geometry*, 7(3): 295-318.
- Mirtich B, Canny J (1994). Easily computable optimum grasps in 2-D and 3-D. *Proceedings of the IEEE International Conference on Robotics and Automation (ICRA)*, San Diego, pp. 739-747.
- Ferrari WD, Canny J (1992). Planning optimal grasps. *Proc. IEEE Int. Confer. Robotics Automation*, pp. 2290-2295.
- Lin Q, Burdick J W (2000) Rimon E. A Stiffness-based Quality Measure for Compliant Grasps and Fixtures. *IEEE Trans. Robotics Automation*, 16(6): 675-688.
- Zheng Y, Qian H (2005). Dynamic force distribution in multifingered grasping by decomposition and positive combination. *IEEE Trans. Robotics*, 21(4): 718-726.
- Cutkosky MR (1989). On Grasp Choice, Grasp Models, and the Design of Hands for Manufacturing Tasks. *IEEE Trans. Robotics Automation*, 15(3): 269-279.
- Stansfield SA (1991). Robotic Grasping of Unknown Objects: A Knowledge-based Approach. *Int. J. Robotics Res.*, 10(4): 314-326.
- Coelho JJr, Grupen R (1994). Control Pre-imaging for Multi-fingered Grasp Synthesis. *Proceedings of the IEEE International Conference on Robotics and Automation (ICRA)*, San Diego, pp. 3117-3122.
- Pollard NS (1996). Synthesizing Grasps from Generalized Prototypes. *Proceedings of the IEEE International Conference on Robotics and Automation (ICRA)*, Minneapolis, 3: 2124-2130.
- Cutkosky M, Wright P (2006). Modeling manufacturing grips and correlations with the design of robotic hands. *Proc. IEEE Int. Confer. Robotics Automation*, 3: 1533-1539, 1986.
- Ceccarelli M, Tavolieri C (2006), Lu Z Design considerations for underactuated grasp with a one D.O.F. anthropomorphic finger mechanism, *Proceedings of the 2006 IEEE/RSJ International Conference on Intelligent Robots and Systems*, Beijing, IROS, pp. 1611-1616.
- Yao S, Ceccarelli M, Carbone G, Lu Z (2008). An Optimal Design for a New Underactuated Finger Mechanism. *Proceeding of second*

European Conference on Mechanism Science (EUCOMES08), Springer, pp. 149-157.  
Zhang Y, Li J, Li J (2007). Robot dexterous hand—modeling, planning and simulation. Beijing: China machine press, 137-160 (in Chinese).  
Skowron A, Rauszer C (1992). Intelligent Decision Support-Handbook of Applications and Advances of the Rough Sets Theory. Kluwer Academic Publishers, Dordrecht.

Walczak B (1999). Massart. Rough sets theory. Chemometr. Intell. Lab. Syst., 47: 1-16.