

Full Length Research Paper

Investigation into the microbial contamination in a spring water distribution system, Western Cape, South Africa

Latiefa Behardien¹, Arnelia Paulse², Vanessa Jackson², Sehaam Khan² and Wesaal Khan^{3*}

¹Department of Food Technology, Faculty of Applied Science, Cape Peninsula University of Technology, Cape Town, 8000, South Africa.

²Department of Biomedical Sciences, Faculty of Health and Wellness Sciences, Cape Peninsula University of Technology, Bellville, 7535, South Africa.

³Department of Agricultural and Food Sciences, Faculty of Applied Science, Cape Peninsula University of Technology, Cape Town, 8000, South Africa.

Accepted 15 July, 2011

The microbial contamination in a spring water distribution system in the Western Cape, South Africa was investigated. Sampling at various points from the spring and throughout the bottling system started in February and continued until November 2004. The number of culturable cells was determined using the heterotrophic plate count (HPC) and total microbial counts were evaluated by flow cytometric analysis (FCM). Heterotrophic plate counts in the final bottled water ranged from 1.34×10^8 cfu/ml (week 1) to 5×10^4 cfu/ml (week 46). In comparison, the total cell counts (FCM) ranged from 2.09×10^8 microorganisms/ml (week 1) to 5.70×10^7 microorganisms/ml (week 46). The higher FCM counts indicated that the flow cytometry technique was able to detect viable but non-culturable organisms in the water and was thus more reliable for the routine quantitative enumeration of microbial populations in water samples. 16S ribosomal ribonucleic acid (rRNA) of the bacterial species present was amplified with PCR and phylogenetic trees were constructed using the neighbour-joining algorithm. The sequenced isolates from the various water samples belonged to the major groups *Bacillus* sp, and *Enterobacteriaceae* and included *Shigella boydii*, *Serratia* sp., *Enterobacter asburiae* and *Pseudomonas* sp.

Key words: Bacterial contamination, flow cytometry, heterotrophic plate count, molecular typing, spring water distribution system.

INTRODUCTION

Natural spring water is obtained directly from underground water sources and is collected under conditions that maintain its natural chemical composition and microbiological purity. According to the South African National Standards for Bottled Water (2003) the source of

the spring must not be situated at or close to any danger of pollution by sewerage, farming operations, waste disposal or industrial activities or any combination of the above pollutant sources. Natural bottled water can also only be subjected to certain treatment processes such as the separation from unstable constituents by decantation and or filtration, aeration, and by any process that will ensure that the natural mineral content is not modified, such as ultraviolet irradiation and ozonation (South Africa Department of Health, 2004).

*Corresponding author. E-mail: wesaalkhan5@gmail.com. Tel: +27 21 460 3175. Fax: +27 21 460 3193.

The microorganisms associated with spring water, which is derived from a ground water source, can also generally be related to the type of microbial pollutants in the soil and the surrounding environment. It is thus essential to assess the microbial contamination risk or the level of pollution at the location of the spring (Leclerc and Moreau, 2002). Coliform bacteria, when detected in treated water supplies, could also be indicative of inadequate treatment, or post treatment of the water system (World Health Organisation, 1996). Coliforms are present in large quantities in soil, and if found in water they usually present a significant health risk. The water source should then be routinely tested for faecal contamination and coliforms are therefore used as indicator organisms in bottled water analysis (Ryan, 2004).

Heterotrophic plate count bacteria are generally used to assess the microbial quality of bottled water (SANS, 2003). In a random survey of bottled water conducted in South Africa by Ehlers et al. (2004), heterotrophic plate counts ranging from 1.1×10^2 to 5.4×10^2 cfu/ml were recorded. It was concluded that the presence of these high numbers were due to the natural microbial flora present in the source water and could thus be used to indicate the level of disinfection of the distribution and bottling system (Leclerc and Moreau, 2002).

Flow cytometry is used to sort and measure different types of cells by the fluorescent labelling of markers on the surface of the cell (Javois, 1999). The addition of fluorescent beads in conjunction with the Live/Dead BacLight™ viability probe allows for the enumeration of total bacteria in the water samples. Paulse et al. (2007) assessed various enumeration techniques to investigate the planktonic bacterial population in the Berg River, Western Cape, South Africa. The heterotrophic plate count technique was used to determine the number of culturable microorganisms in the water samples and flow cytometry was used to evaluate the total bacterial counts. The study indicated that the average heterotrophic plate count represented only a fraction (< 3.65%) of the total flow cytometric analysis (FCM) counts and < 6.06% of the viable FCM count.

Beuret et al. (2002) monitored three brands of natural mineral waters in Europe over a one year period to investigate and identify the microbial flora present. Norovirus sequences were isolated from three leading European brands of still mineral water, during the course of this investigation. Research by Leclerc (2002) on the microbiological safety of bottled water, identified the major species of bacteria associated with natural mineral water as *Pseudomonas* fluorescent species, *Pseudomonas* non-fluorescent species, *Acinetobacter*, *Alcaligenes*, *Comamonas* spp., *Cyto-phaga Flavobacterium*, *Arthrobacter* and *Corynebacterium*.

The advantages of polymerase chain reaction (PCR) in relation to other culture techniques or standard methods

used for the detection of microbial pathogens in water, is that it is specific, sensitive, rapid, accurate and can detect small amounts of nucleic acids in a single sample. Tsen et al. (1998) utilised PCR to select regions of the *Escherichia coli* 16 S ribosomal ribonucleic acid (rRNA) gene to detect these cells in water. The addition of an enrichment step allowed for a detection limit of as low as one *E. coli* cell /100 ml.

A spring water distribution system in the Western Cape, South Africa experienced quality problems associated with bacterial contamination. The aim of this study was to investigate the bacterial contamination in this spring water bottling system. The level of heterotrophic plate counts (HPC) in the water samples at various sites throughout the system were determined by the conventional plate count technique. In addition, flow cytometric analysis was used to obtain total cell counts (the culturable and non-culturable populations) in the collected water samples at the various sites. Identification of microorganisms in the water samples was performed by means of molecular typing.

MATERIALS AND METHODS

Sampling sites

Sampling sites at the spring water distribution system in the Western Cape, South Africa are indicated in Figure 1. The sites include; Site A (borehole one); Site B (borehole two); Site C (Dositron – Flushing point); Site D (between 0.3 µm filter and UV steriliser –outside factory), Site E [After ultraviolet (UV)]; the bottling line then splits into two lines and either one of the lines can be used for bottling. Site F (Line one after 0.35µm filter); Site G (Line one after 0.2 µm filter); Site H (Line two after 0.35 µm filter); Site I (Line two after 0.2 µm filter) and Site J (at filler- final bottling point). Sampling of these sites started in March 2004 (sampling batch one; week one and sampling batch two; week four) and continued in April (sampling batch three; week eight) until November 2004 (sampling batch four; week 46). Water samples were collected in 1 L sterile Nalgene-polypropylene bottles and stored on ice to maintain a low temperature.

Heterotrophic plate count technique and pure culture isolation

Total heterotrophic plate counts were performed in duplicate on R2A Agar (Merck, Biolab Diagnostics) after serial dilutions 10^{-1} to 10^{-7} of sample water was performed. Plates were incubated for 24 to 48 h at 37°C. Thereafter the number of visible cells, or colony forming units (CFU's) were counted and recorded. Distinct visible cells CFU's were identified and subcultured onto clean Nutrient Agar (NA) (Merck, Biolab Diagnostics) plates for further purification of cultures.

Flow cytometry (FCM)

The FCM outlined by Paulse et al. (2007) was employed in the present study. Individual samples were subjected to a Becton Dickinson FACSCalibur flow cytometer for analysis. The Becton Dickinson FACSCalibur flow cytometer has a 15 mW, 488 nm

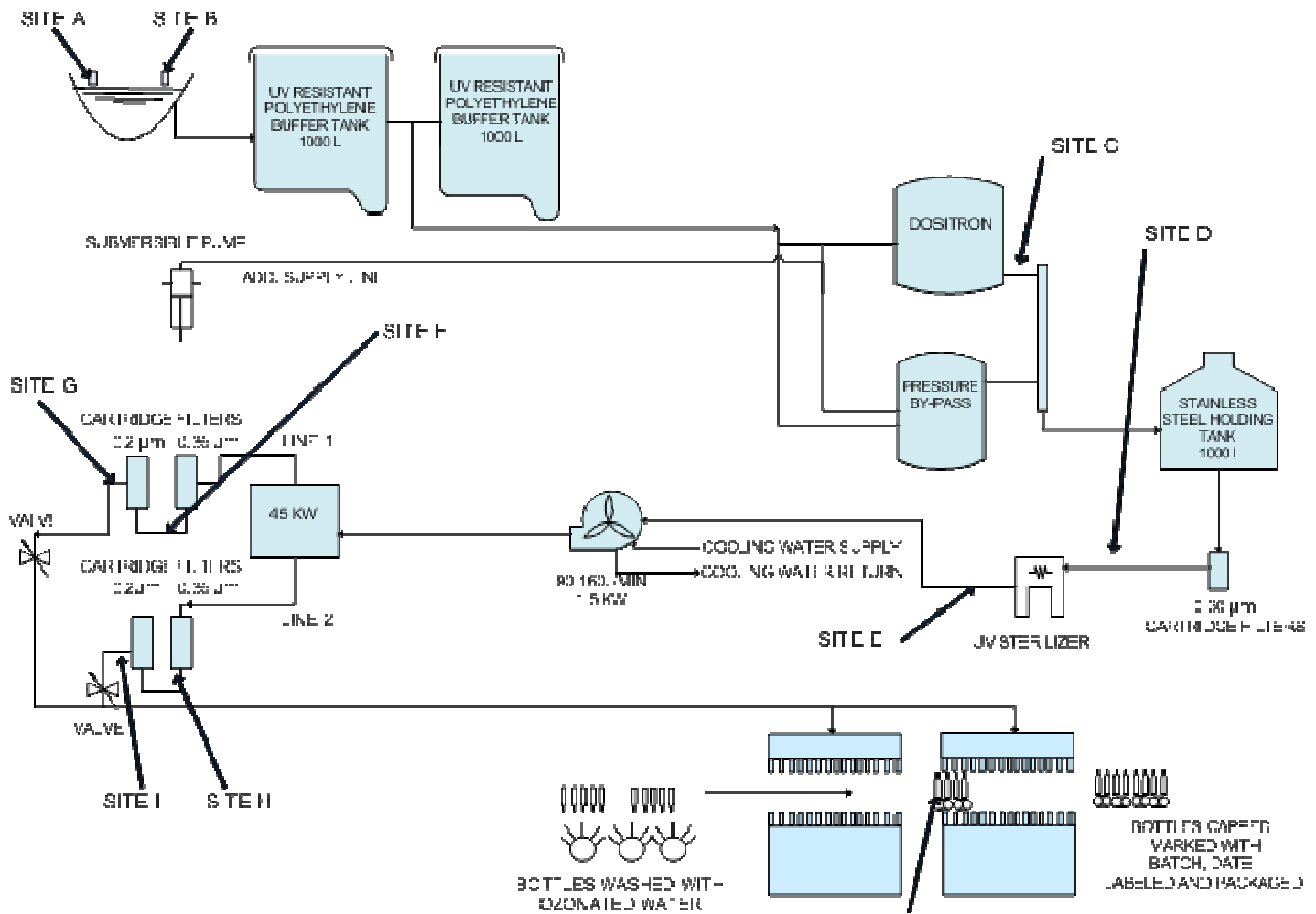

Figure 1. Diagram of the borehole and bottling plant indicating sampling points.

argon-ion laser. A Doublet Discrimination Module, which uses pulse width and area to eliminate cell clumping (doublets and triplets), in conjunction with a LIVE/DEAD™ bacterial stain, allows for the differentiation between bacterial cells and debris. An *E. coli* laboratory strain was used as control.

$$\frac{\text{Number of events in cell region}}{\text{Number of events in bead region}} \times \frac{\text{Number of beads / test}}{\text{Test volume}} \times \text{Dilution} \quad (1)$$

[Bead concentration recorded at 988/µl for the Liquid Counting Beads and at 49827 beads per Trucount™ tube, both obtained from Biolab Diagnostics™]

DNA extraction and Agarose Gel electrophoresis

Cultures from planktonic samples obtained from the sampling sites were spread-plated onto Nutrient Agar (NA) (Merck, Biolab Diagnostics) after serial dilutions (10^{-1} to 10^{-7}) of sample water were

performed. Plates were incubated for 3-4 days at 37°C. Thereafter, distinct visible cells [colony forming units (CFU)] were identified based on morphological differences and re-streaked onto clean NA plates for isolation of pure cultures. Deoxyribonucleic acid (DNA) extraction was performed using the High Pure PCR Template Preparation Kit as per manufacturer’s instructions (Roche Diagnostics). Extracted DNA samples (10 µl) were electrophoretically analysed on a 0.8% molecular grade agarose gel containing 12 µl of 0.5 µg/ml ethidium bromide, using 1 x Tris-acetate- ethylenediamine tetraacetic acid (TAE) electrophoresis buffer and run for one hour at 90 volts to confirm the presence of genomic DNA.

Polymerase chain reaction (PCR)

The extracted DNA from individual samples was amplified using two primer sets, respectively. Amplification of target DNA samples (5 µl) by PCR was performed in a total reaction volume of 50 µl containing a 10 mM dNTP mix (1 µl), 25 mM MgCl₂ (4 µl), 5 x PCR Buffer with (NH₄)₂SO₄ (10 µl), 10 µM forward (RW01) primer [AAC

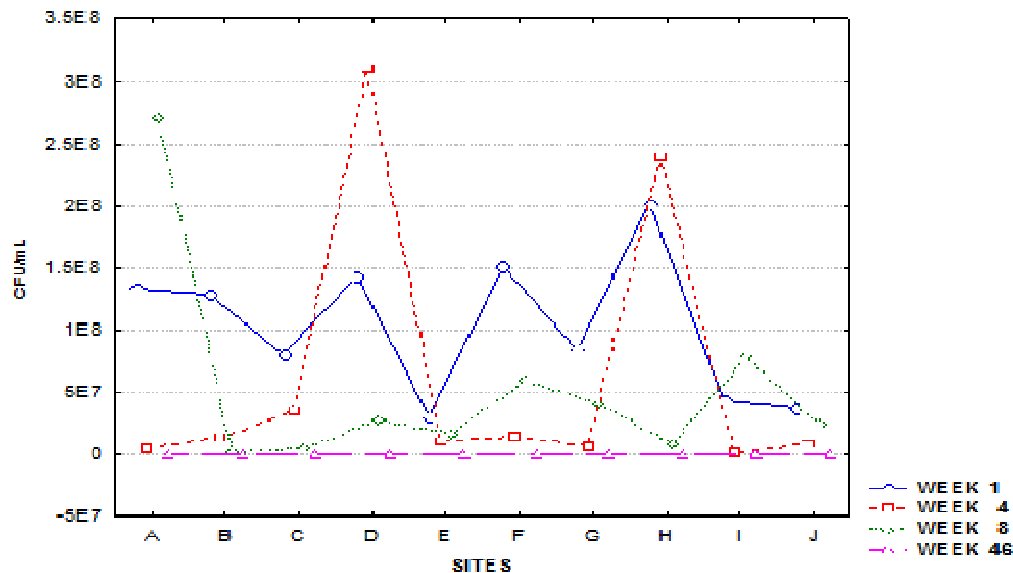

Figure 2. Average heterotrophic plate counts for the sites analysed recorded over the sampling period.

TGG AGG AAG GTG GGG AT] (2.5 μ l), 10 μ M reverse (DG74) primer [AGG AGG TGA TCC AAC CGC A] (2.5 μ l) (Greisen et al., 1994), GoTaq DNA polymerase (0.25 μ l) and sterile distilled H₂O (24.75 μ l). For the second primer set all the reagents mentioned above were added proportionally, together with 10 μ M forward (RDR080) primer [AAC TGG AGG AAG GTG GGG AC] (2.5 μ l) and 10 μ M reverse (DG74) primer [AGG AGG TGA TCC AAC CGC A] (2.5 μ l) (Greisen et al., 1994) to obtain a total volume of 50 μ l for subsequent amplification. The PCR procedure included an initial denaturation step of 5 min at 95°C, followed by 30 cycles of amplification (25 s at 95°C, 25 s 55°C and 1 min at 72°C). The final extension step was performed at 72°C for 10 min. Ten microliters of the amplified DNA fragments of the PCR reactions were analysed on a 1.2% agarose gel containing 12 μ l of 0.5 μ g/ml ethidium bromide, using 1 x TAE electrophoresis buffer and run at 90 volts for one hour to confirm successful amplification of the PCR product.

16S ribosomal RNA sequencing

Successfully amplified PCR products (~400 kb) were purified using a High Pure PCR Product Purification Kit as per the manufacturer's instructions (Roche Diagnostics). The DNA concentrations were determined using the Qubit™ fluorometer (Invitrogen) and the Quant-iT™ dsDNA BR (Broad-range) Assay kit 2–1000 ng as per manufacturer's instructions (Molecular probes and Invitrogen). Samples were loaded onto 96-well plates (15 μ l per sample), dried in a speed vac with medium heat for 30 to 60 minutes (depending on the volumes) and sent for subsequent sequencing where the Applied Biosystems Big Dye Terminator v3.1 Cycle sequencing Kit was used for the sequencing reactions, as per manufacturers' protocols. Sequences were identified using the (Blastn) or Local Alignment Search Tool Basic (Altschul et al., 1997) obtained from the National Centre for Biotechnology Information website.

Phylogenetic analysis

All the DNA sequences obtained from water at the various sites

over the four sampling weeks were grouped and aligned with ClustalX (1.81) using default parameters and the Blossum matrix. An unrooted tree was constructed using the neighbour-joining (Saitou and Nei, 1987) program of MEGA version 4.1 (Molecular Evolutionary Genetics Analysis 4.1) (Tamura et al., 2007). Branching patterns were evaluated by pairing 1000 replicates.

Statistical analysis

Repeated measures analysis of variance (ANOVA) [RMA] were performed on all data obtained as outlined in Dunn and Clark (1987) using Statistica™. In each RMA, the residuals were analysed to determine if they were normally distributed. In all hypothesis tests, a significant level of 5% was used as standards.

RESULTS AND DISCUSSION

Heterotrophic plate counts (HPC)

Total culturable microbial counts obtained by the HPC technique for all the sampling sites throughout the study period are presented in Figure 2. The HPC recorded in week one ranged from 1.34×10^8 cfu/ml at the borehole (Site A) to 3.66×10^7 cfu/ml in the final bottled water (Site J). The highest count of 2.02×10^8 cfu/ml was observed after the 0.35 μ m filter in line two (Site H) while the lowest count of 3.0×10^7 cfu/ml was observed after ultraviolet irradiation (Site E). The spring water system was experiencing problems with bacterial contamination and the high counts could be ascribed to the fact that the 0.35 μ m filter of line two was contaminated, clogged or faulty or that a biofilm was present in the distribution system which periodically sloughed off and served as a

continuous source of contamination. In spring water distribution systems however, filters must be backwashed on a regular basis to maintain the integrity of the filter system, as non-fixed pore filters enlarge in pore size after high water volumes have passed through them, thus resulting in the release of trapped contaminants into the filtered water (Pall Filters, 2004). The lowest count observed after UV indicated that the UV treatment was effective in reducing the number of microorganisms, however, the initial number of microorganisms in the water was significantly high, and thus the UV irradiation only reduced the microorganisms by one log cycle. Senior and Dege (2005) confirmed that the efficiency of UV irradiation as with any other disinfection process is dependant on the quality of the incoming source water.

The HPC recorded in week four ranged from 4.50×10^6 cfu/ml at the borehole (Site A) to 9.00×10^6 cfu/ml in the final bottled water (Site J). Increases in cfu/ml were recorded after the $0.3 \mu\text{m}$ filter (Site D) at 3.10×10^8 cfu/ml and again after the $0.35 \mu\text{m}$ filter in line two (Site H) at 2.39×10^8 cfu/ml. Blocked or contaminated filters could have influenced the significant increase in HPC counts recorded after these filters (Site D and H). A significant decrease is however, noted after the water passes through the UV system (Site E), line one at both the $0.35 \mu\text{m}$ and $0.2 \mu\text{m}$ filters and the $0.2 \mu\text{m}$ filter in line two (Site I). This indicates that these filters were still functioning at their maximum efficiency. An increase in the microbial count was recorded in the final bottled water (Site J), which indicated that the filler ports were either contaminated or had not been sanitised correctly. The final microbial count of 9.0×10^6 cfu/ml (Site J) significantly exceeded the South African National Standard for HPC for bottled water of < 100 organisms/ml.

The HPC recorded in week eight ranged from 2.70×10^8 cfu/ml at source (Site A) to 2.35×10^7 cfu/ml in the final bottled water (Site J). The highest count was recorded at the borehole (Site A) indicating that the source water still contained significantly high numbers of microorganisms, which would influence the filtration process and the HPC count in the final bottled water. The HPC count in the final bottled water (Site J) in week eight was 2.35×10^7 cfu/ml in comparison to week one and four where counts of 3.66×10^7 cfu/ml and 9.00×10^6 cfu/ml were recorded, respectively. The distribution system was undergoing chlorine and oxonia disinfection treatment processes to reduce microbial counts, but the disinfection process was still not adequate to reduce the number of microorganisms to the acceptable level of < 100 microorganisms/ml in the final bottled water. This implied that based on the results for weeks one, four and eight the spring water distribution system investigated, required additional chlorine disinfections washes and the filters had to be sanitised, backwashed or replaced to achieve the legal requirement.

The HPC recorded in week 46 ranged from 4.5×10^5

cfu/ml at source (Site A) to 5.0×10^4 cfu/ml in the final bottled water (Site J). The lowest HPC count was recorded in the final bottled water while the highest microbial count of 7.5×10^5 cfu/ml was observed after UV irradiation (Site E). In week 46 a significant reduction in HPC in comparison to week one, four and eight was recorded for all sites as the system had been routinely disinfected with chlorine soaks and oxonia. Contact times and dosage for disinfecting the system were increased and the filters were disinfected and backwashed. However, the HPC count in the final bottled water still significantly ($p < 0.05$) exceeded the acceptable limit of < 100 organisms/ml.

Flow cytometric analysis (FCM)

The total cell counts obtained by flow cytometric analysis are presented in Figures 3 and 4. The total cell counts obtained in week one ranged from 2.09×10^8 microorganisms/ml at the large borehole (Site A) to 5.44×10^7 microorganisms/ml in the final bottled product (Site J). In addition, significantly high total cell counts were observed at the small borehole (Site B) at 2.03×10^8 microorganisms/ml, Dositron (Site C) at 1.88×10^8 microorganisms/ml, and after the $0.35 \mu\text{m}$ filter in line one (Site F) at 1.56×10^8 microorganisms/ml. The marked increase in the total cell count observed after the $0.35 \mu\text{m}$ filter in line one (Site F) indicated that the filter was blocked and required sanitisation, backwashing or replacement. A decrease in the total cell counts at Site D at 6.13×10^7 microorganisms/ml, Site G at 2.58×10^7 microorganisms/ml, and Site I at 2.11×10^7 microorganisms/ml, can be observed which indicated that the filter system at these sites successfully retained some of the bacterial load and supported the implementation of multiple filter systems in a spring water distribution system.

The total cell counts in week four ranged from 3.90×10^7 microorganisms/ml at the large borehole (Site A) to 8.36×10^7 microorganisms/ml in the final bottled product (Site J), with the lowest total cell count observed at the Dositron unit (Site C) at 2.13×10^7 microorganisms/ml. The total cell count for Site F in week four could not be measured as the sample vial broke. The high total counts in the final bottled water in week four indicated that although the bottling system was sanitised with chlorine and oxonia, an increase in the cell count was recorded from source to final product, which implied that there was definitely a source of contamination in the distribution system.

Tchobanoglous and Schroeder (1985) indicated that the factors which influence the disinfection efficiency of chlorine include the initial contact time, concentration and form, microbial load, pH and temperature. The bottling system of the site investigated was dosed with

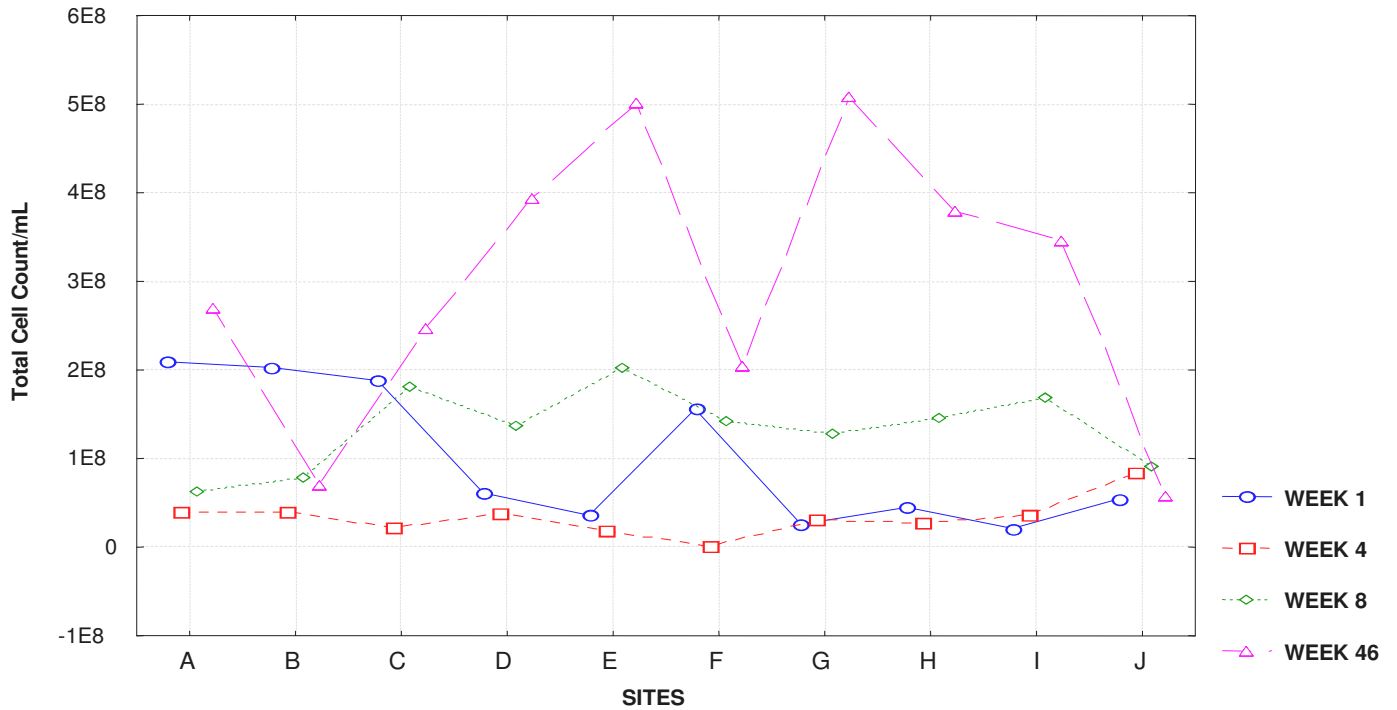

Figure 3. Enumeration of total bacteria by means of flow cytometric analysis (FCM) recorder over the sampling period.

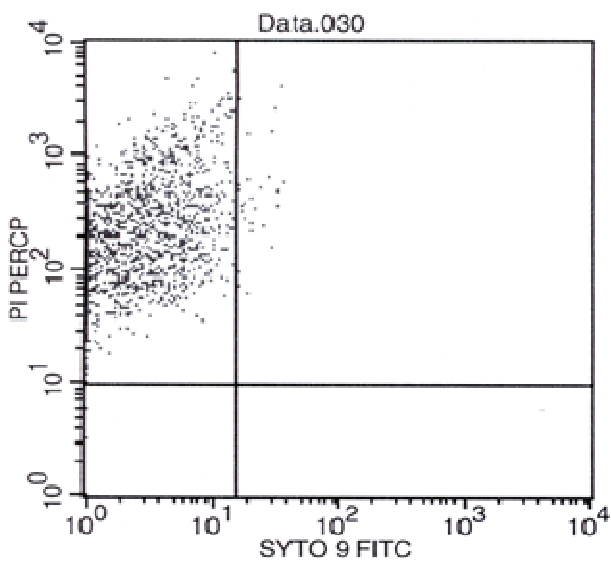

Figure 4a. Dotplots of planktonic samples obtained at the borehole for week 46 of the distribution site in the Western Cape by means of Flow cytometric analyses (FCM).

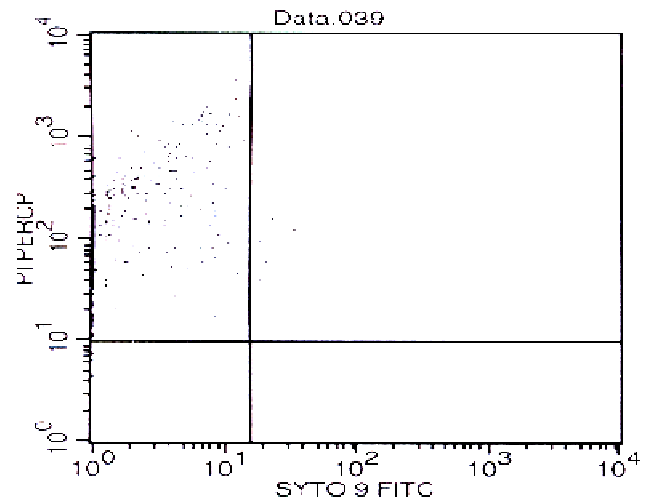

Figure 4b. Dotplots of planktonic samples obtained in the final bottled water for week 46 of the distribution site in the Western Cape by means of Flow cytometric analyses (FCM).

concentrated chlorine and left to stand for two days to increase its contact time. The initial counts in the source water in week four of 3.90×10^7 microorganisms/ml and 3.88×10^7 microorganisms/ml at Sites A and B,

respectively were however, lower than the microbial counts recorded at source in week one at 2.09×10^8 microorganisms/ml (Site A) and 2.03×10^8 microorganisms/ml (Site B). The results indicate that the precautions implemented to secure the borehole sites such as the tapping of the boreholes, improved the

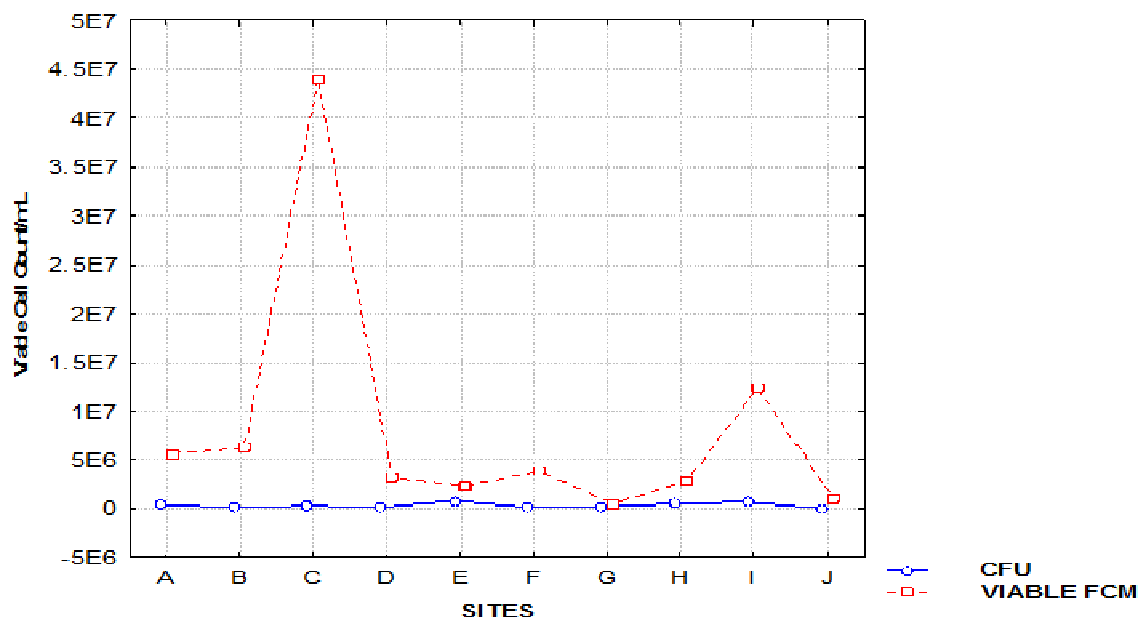

Figure 5. Comparison of heterotrophic plate count to viable FCM count for week 46 for the sites analysed.

source water quality.

The total cell counts in week eight ranged from 6.25×10^7 microorganisms/ml (Site A) to 9.09×10^7 microorganisms/ml (Site J). The highest total cell count of 2.02×10^8 microorganisms/ml was recorded after UV irradiation (Site E). For a UV light to function optimally the quartz must be cleaned regularly to ensure full transmissivity and efficacy (Senior and Dege, 2005). Sommer and Cabaj (1993) evaluated the efficiency of a UV plant for the disinfection of drinking water and concluded that biosimetric conditions should be used to monitor disinfection efficiency. High counts of 1.80×10^8 microorganisms/ml at the Dositron (Site C) and 1.69×10^8 microorganisms/ml after the 0.2 μm filter line two (Site I) were also observed, which indicated that the dositron (point where sanitiser is added to the system) was perhaps not sealed or was exposed to an external source of contamination. Membrane fouling which is caused by the accumulation of chemicals, particles and growth of microorganisms on the membrane surface could also have contributed to the increase in microbial counts (Guidelines for Canadian Water Quality, 2008).

Due to the consistent contamination experienced, the production at the supplier was stopped and the problem was investigated. Sampling was resumed three months later to measure the efficiency of the treatment procedures implemented. The total cell counts recorded in week 46 ranged from 2.69×10^8 microorganisms/ml at the large borehole (Site A) to 5.70×10^7 microorganisms/ml in the final bottled product (Site J). Results in week 46 fluctuated with the highest total cell counts of 5×10^8 microorganisms/ml and 5.08×10^8 microorganisms/ml

observed after UV irradiation treatment (Site E) and the 0.2 μm filter in line one (Site G), respectively. The high total cell count recorded after the UV irradiation treatment in week 46, compared to week one, four and eight indicated the reduction in the efficiency of the quartz and clearly showed that the lamp needed replacement.

In comparison to the other sampling weeks, low HPC counts were observed in week 46, which indicated that even though the counts still exceeded the stipulated HPC limit, the treatment procedures implemented were effective in reducing the CFU counts. However, the flow cytometry results showed that the total cell counts of week 46 were higher than all the other weeks sampled, which clearly indicates that the HPC count was not a true reflection of the microbial numbers in the spring water distribution system.

The heterotrophic plate counts were thus compared to the viable cell counts as obtained by flow cytometry. The results for week 46 only (Figure 5) are discussed as a representation of results as significant differences were recorded in the HPC and FCM counts for this week. These results showed that the flow cytometric (FCM) analysis yielded higher viable counts in the water sampled at the various sites. The highest CFU count of 7.50×10^5 microorganisms/ml was recorded after the UV irradiation process (Site E). A corresponding FCM viable count of 2.17×10^6 microorganisms/ml was recorded for the same sampling site. The highest viable FCM count for week 46 was observed at the Dositron (Site C) at 4.40×10^7 microorganisms/ml. A corresponding CFU count of 3.00×10^5 microorganism s/ml was recorded for the same sampling site. The current water legislation, states that

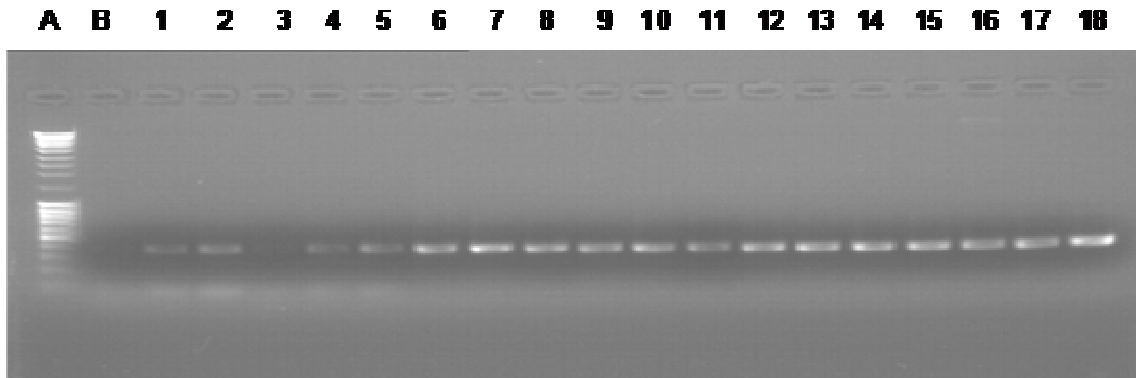

Figure 6a. Polymerase Chain Reaction analysis of extracted DNA samples (BB1-138 to 155) [with primer set 1: forward (RW01) primer; reverse (DG74) primer] for sampling week 4. Lanes 1 –18: samples 14 to 32; Lane A: Marker [MassRuler™ DNA Ladder Mix, #SM0403 (Fermentas)]; Lane B: Negative control.

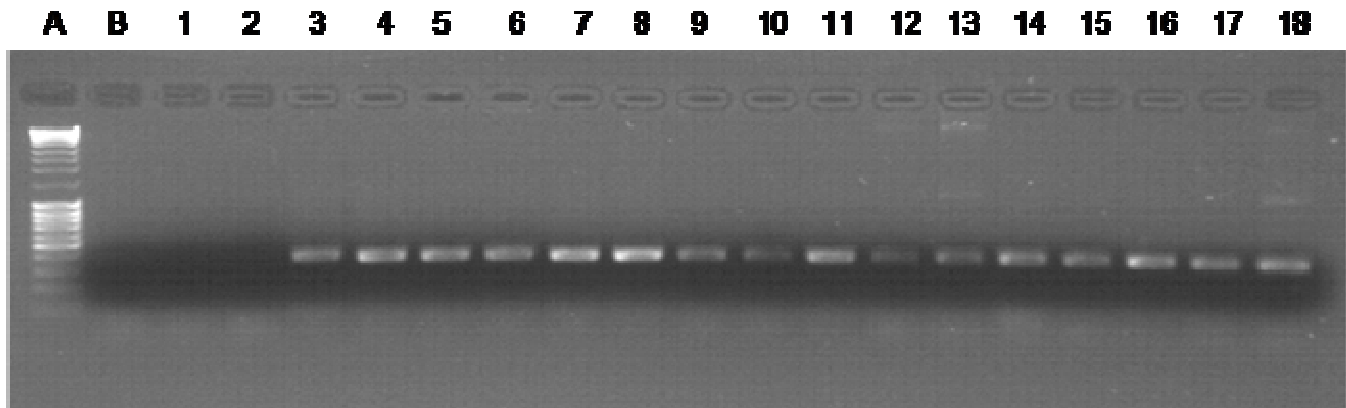

Figure 6b. Polymerase Chain Reaction analysis of extracted DNA samples (BB1-138 to 155) [with primer set 2: forward (RW080) primer; reverse (DG74) primer] for sampling week 4. Lanes 1 –18: samples 14 to 32; Lane A: Marker [MassRuler™ DNA Ladder Mix, #SM0403 (Fermentas)]; Lane B: Negative control.

the heterotrophic plate count of the final bottled water must be < 100 organisms/ml within 24 hours of bottling however, no stipulation regulation for FCM in bottled water could be found. Results clearly showed that in comparison to the FCM technique, the heterotrophic plate count technique, only allows for growth of the viable and culturable cells present in the water samples and that it is not an accurate method to assess the actual viable microbial population in the bottled water samples (Paulse et al., 2007).

Phylogenetic analysis

Figure 6 (a) and (b) represents the purified PCR agarose gel electrophoresis photos of week 4 using both primer sets 1 and 2. Lane one contains the DNA ladder # SM0402 and lane two contains the negative control.

Phylogeny of 180 sequences were analysed and there were many similar species that were repeatedly isolated from the various sampling points over the sampling periods. Their duplicate species were excluded as shown in Figures 7 to 10. Species that were similar and belonged to the same family were grouped together to form clades. Bootstrap values for all scores were on average above 90. Tables 1 to 4 indicate the different bacterial species isolated from the various sites and their GenBank accession numbers.

In week one, 16 diverse species were isolated and a phylogenetic tree was constructed (Figure 7). Amongst the organisms isolated were *Shigella boydii*, *Serratia* sp. *SB*, *Enterobacter asburiae*, all of which belong to the family *Enterobacteriaceae*. *Serratia* belongs to the coliform group and occurs in the environment, where their presence usually indicates faecal contamination. In developing countries contaminated drinking water is still

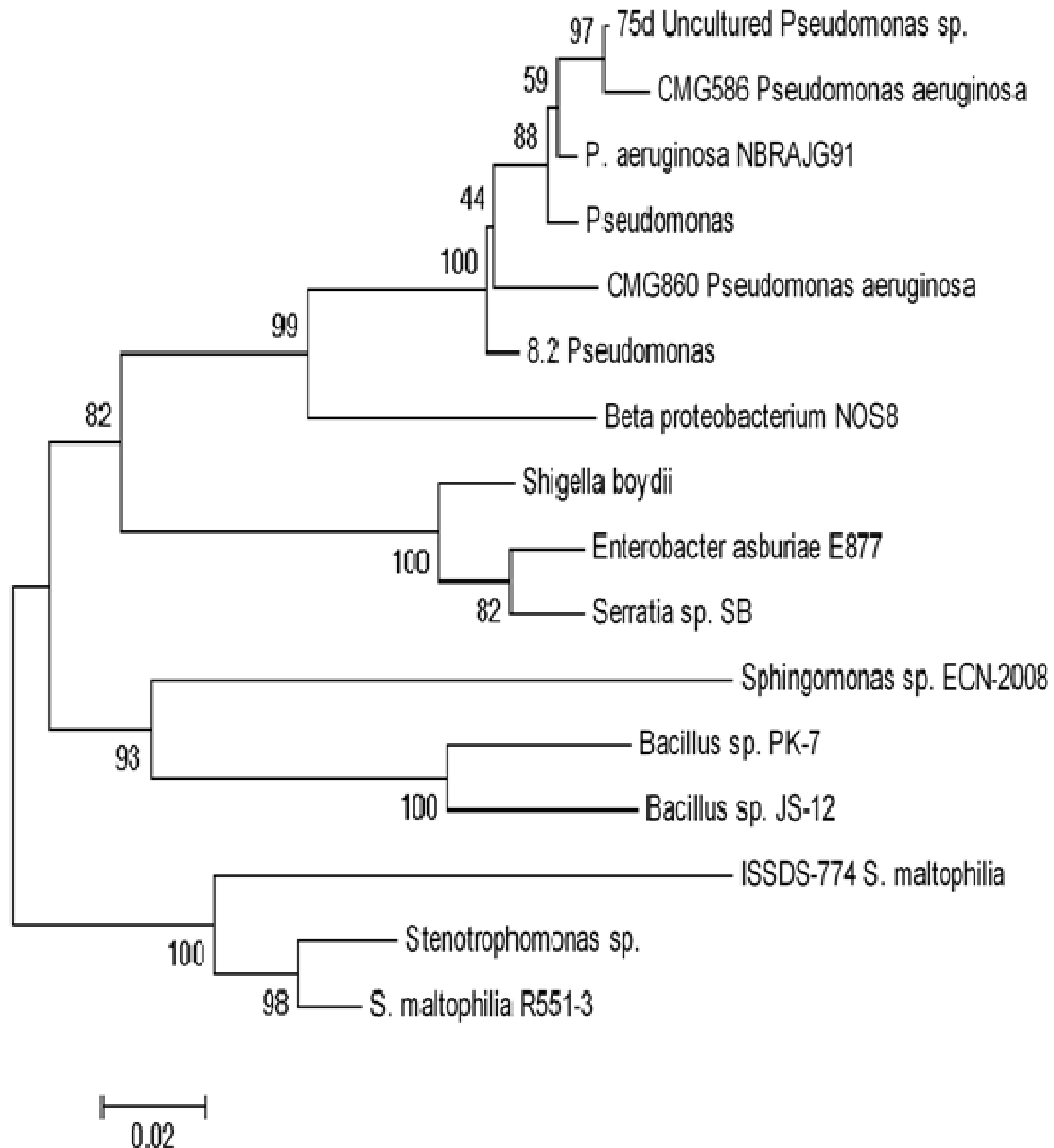

Figure 7. Phylogenetic tree inferred from 16S rRNA sequence data, isolated from bacterial samples obtained from water samples taken in week 1 from the distribution system in Western Cape, South Africa. Distance matrices were constructed from the aligned sequences and created for multiple base changes at single position by the BLOSUM algorithm.

also a major cause of shigellosis (Ray, 2004). *Pseudomonas* and *Stenotrophomonas* sp. have also frequently been isolated from mineral water (Leclerc, 2002).

In week four, 17 diverse species were isolated and a phylogenetic tree was constructed (Figure 8). All the species in this sampling week with the exception of *Pseudomonas* sp. and *Bacillus* sp. were introduced in this sampling period. In week four the highest HPC

counts were recorded at the filters (Figure 2) and it could be at these contamination points where these species were introduced. The presence of the *Pseudomonas* sp. and *Bacillus* also indicated that the sanitisation process, although adjusted was still not effective in the elimination of these organisms from the water.

In week eight, 41 diverse species were isolated and a phylogenetic tree was constructed (Figure 9). The highest HPC count for all the sampling periods was recorded in

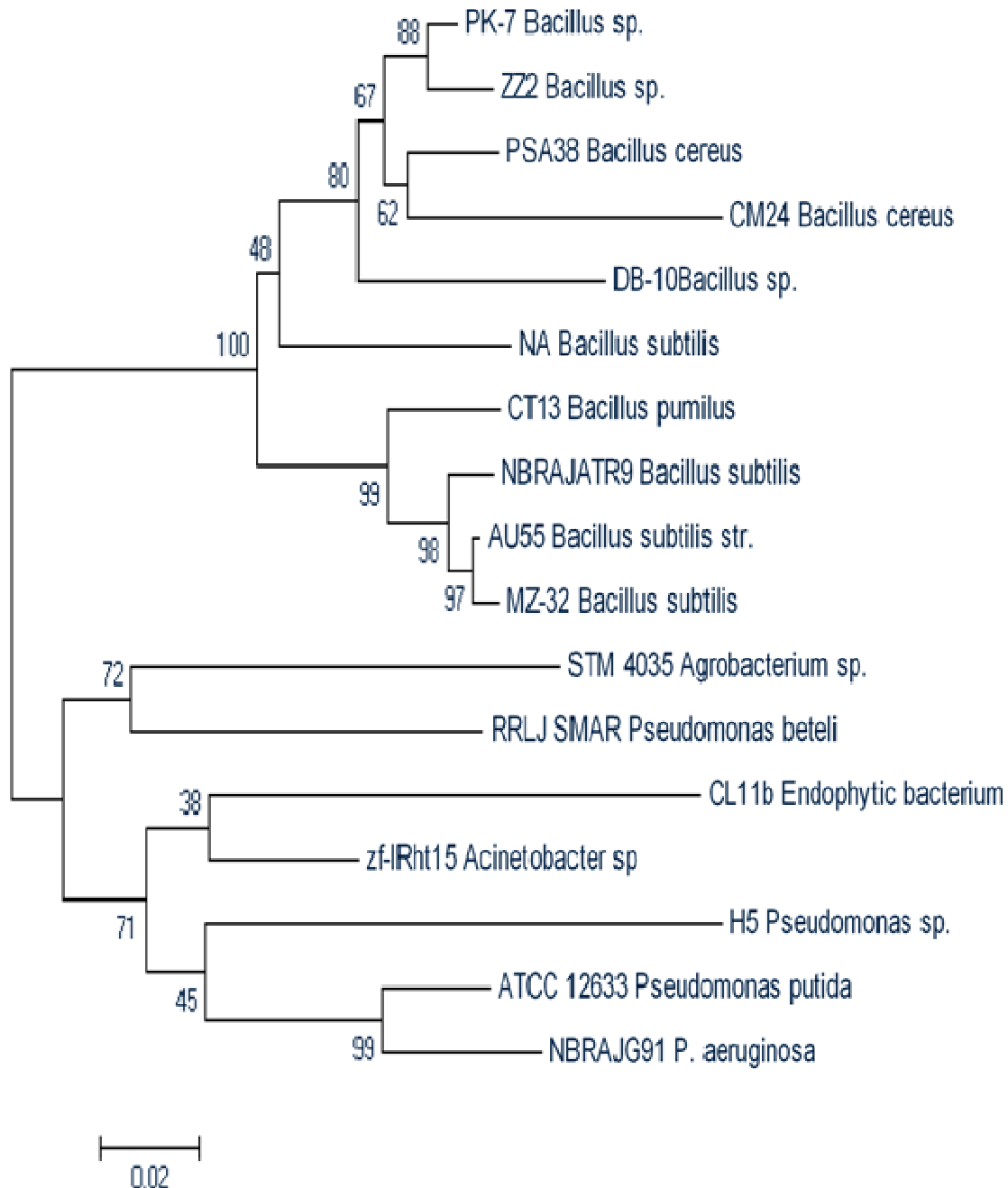

Figure 8. Phylogenetic tree inferred from 16S rRNA sequence data, isolated from bacterial samples obtained from water samples taken in week 4 from the distribution system in Western Cape, South Africa. Distance matrices were constructed from the aligned sequences and created for multiple base changes at single position by the BLOSUM algorithm.

week eight at the large borehole (Figure 2) and clearly indicated the most pronounced point of contamination and species introduction. The species introduced in this sampling period included *Commamonas aquatica*, *Proteus* sp. K10, 7 *Proteus mirabilis*, *Hafnia alvei* CCUG 429, *Enterobacter* sp. NJ-64, *Enterobacter* sp. MB-1-6-6,

Amorphomonas oryzae B46, amongst others. The presence of *Pseudomonas* sp. and *Bacillus* sp. again indicate that these organisms were not eliminated during the sanitisation process. The sanitisation process and conditions were either insufficient to eliminate these organisms or they could have formed a biofilm within the

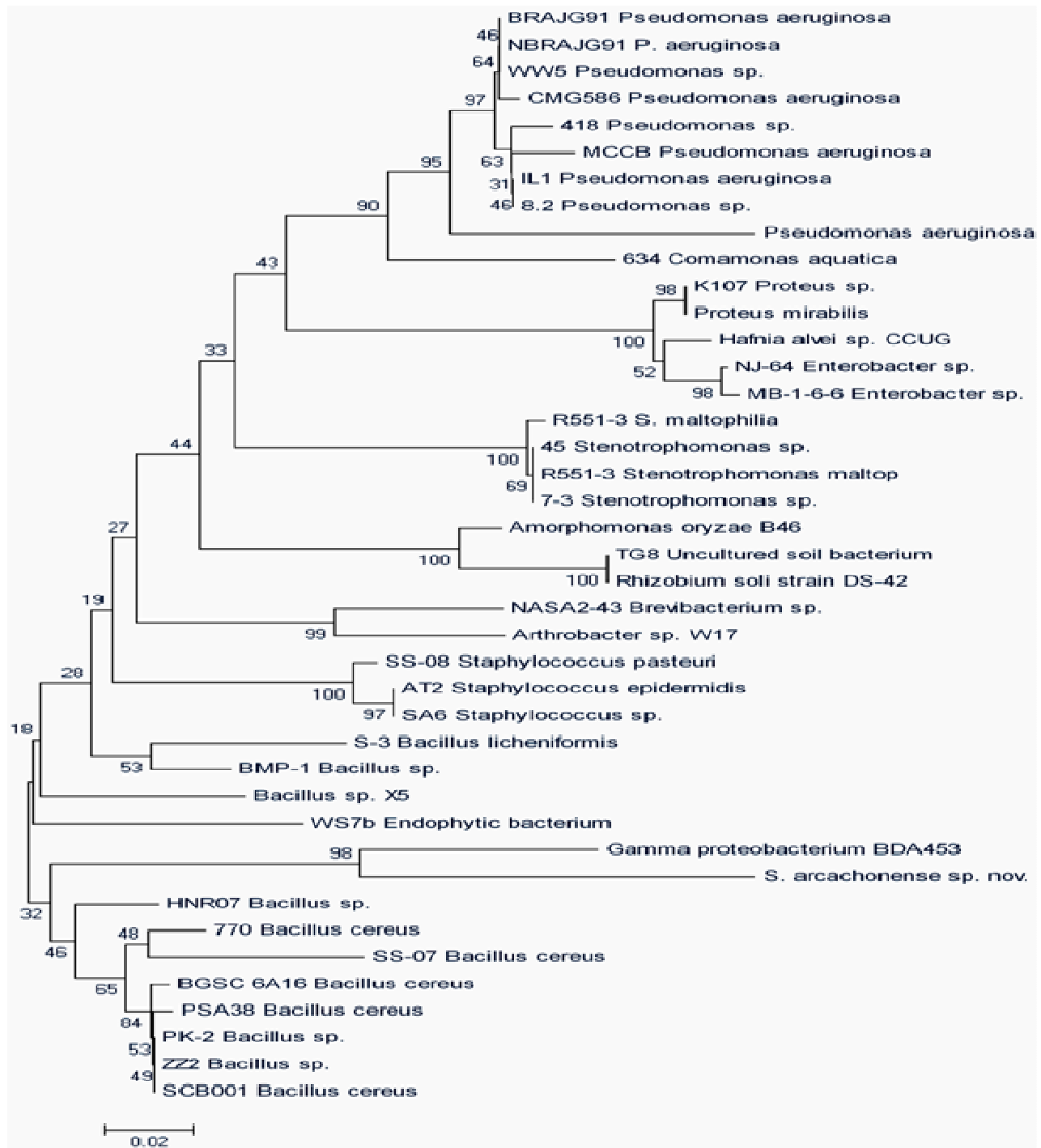

Figure 9. Phylogenetic tree inferred from 16S rRNA sequence data, isolated from bacterial samples obtained from water samples taken in week 8 from the distribution system in Western Cape, South Africa. Distance matrices were constructed from the aligned sequences and created for multiple base changes at single position by the BLOSUM algorithm.

distribution system.

In week 46, only 13 different species were isolated and a phylogenetic tree was constructed (Figure 10). The low species diversity correlates with the HPC count observed

in week 46, which was the lowest count for all the sampling periods (Figure 2). The presence of *Pseudomonas* sp. and *Bacillus* sp. again indicate that these species were not eliminated during the sanitisation

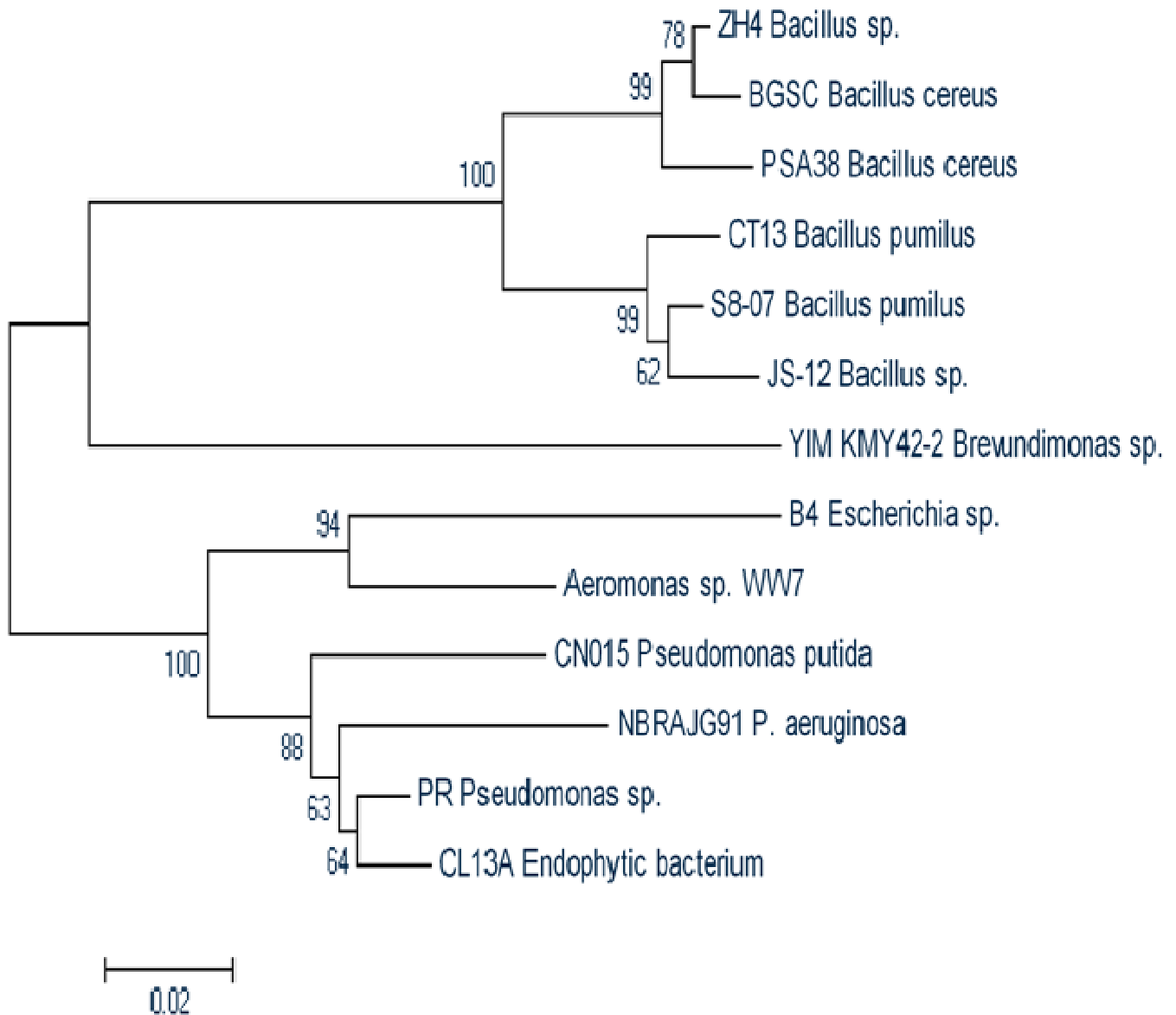

Figure 10. 16S rRNA sequence data, isolated from bacterial samples obtained from water samples taken in week 46 from the distribution system in Western Cape, South Africa. Distance matrices were constructed from the aligned sequences and created for multiple base changes at single position by the BLOSUM algorithm.

process and their persistence definitely indicates a biofilm in the system. A study conducted by Percival et al. (1998) on the development of biofilms on stainless steel pipes in a mains water system indicated that the dominant species isolated were *Pseudomonas* spp. and *Alcaligenes* sp. In week 46, the following species *Escherichia* sp. *Aeromonas*, *Endophytic* bacteria and *Brevundimonas* sp. were introduced. *Escherichia* sp. B4 belong to the family *Enterobacteriaceae* and certain strains cause foodborne gastroenteritis. The presence of *Escherichia coli* also usually indicates faecal contamination (Ray, 2004).

The microbial flora isolated over the sampling period was mainly *Pseudomonas* sp., *Bacillus* sp., *Staphylococcus* sp. and *Stenotrophomonas* sp. Pathogens isolated over the sampling period include *Pseudomonas* sp., *Shigella*, and *Staphylococcus* sp. It is thus important to understand quantitatively the bacterial diversity in the bottling water distribution system in order to apply and optimise the correct sanitisation procedure. As bottled water cannot be subjected to any chemical treatments during and after bottling it is important to apply effective sanitisation, manage the filter integrity, UV

Table 1. Table of 16 isolates, their codes and accession numbers for organisms isolated from week 1 sampling period.

Name presented on tree	Organism	Accession number
75d Uncultured <i>Pseudomonas</i> sp.	Clone_75d_Uncultured_ <i>Pseudomonas</i> sp.	EF593077.1
CMG586 <i>Pseudomonas aeruginosa</i>	<i>Pseudomonas aeruginosa</i> strain CMG586	EU194236.1
NBRAJG91 <i>P. aeruginosa</i>	<i>Pseudomonas aeruginosa</i> strain NBRAJG91	EU661707.1
WW5 <i>Pseudomonas</i> sp	<i>Pseudomonas</i> sp. WW5	EF433547.1
CMG860 <i>Pseudomonas aeruginosa</i>	<i>Pseudomonas aeruginosa</i> strain CMG860	EF511771.1
<i>Pseudomonas</i> sp.	<i>Pseudomonas</i> sp.	EF426444.1
<i>Beta proteobacterium</i> NOS8	<i>Beta proteobacterium</i> NOS8	AB076846.1
<i>Shigella boydii</i>	<i>Shigella boydii</i>	AB273731.1
<i>Serratia</i> sp. SB	<i>Serratia</i> sp. SB	EU816383.1
E877 <i>Enterobacter asburiae</i>	<i>Enterobacter asburiae</i> strain E877	EF059885.1
<i>Sphingomonas</i> sp. ECN-2008	<i>Sphingomonas</i> sp. ECN-2008	AM940945.1
<i>Bacillus</i> sp. PK-7	<i>Bacillus</i> sp. PK-7	EU685824.1
JS-12 <i>Bacillus</i> sp	<i>Bacillus</i> sp. JS-12	EF040535.1
ISSDS-774 <i>S. maltophilia</i>	<i>Stenotrophomonas maltophilia</i> strain ISSDS-774	EF620464.1
<i>Stenotrophomonas</i> sp.	<i>Stenotrophomonas</i> sp.	AJ884482.1
R551-3 <i>S. maltophilia</i>	<i>Stenotrophomonas maltophilia</i> R551-3	CP001111.1

Table 2. Table of 17 isolates, their codes and accession numbers for organisms isolated from week 4 sampling period.

Name presented on tree	Organism	Accession number
PK-7 <i>Bacillus</i> sp	<i>Bacillus</i> sp. PK-7	EU685824.1
ZZ2 <i>Bacillus</i> sp	<i>Bacillus</i> sp. ZZ2	DQ113449.1
PSA38 <i>Bacillus cereus</i>	<i>Bacillus cereus</i> strain PSA38	EU346663.1
CM24 <i>Bacillus cereus</i>	<i>Bacillus cereus</i> strain CM24	EU660318.
DB-10 <i>Bacillus</i> sp	<i>Bacillus</i> sp. DB-10	EU439408.1
NA <i>Bacillus subtilis</i>	<i>Bacillus subtilis</i> strain NA	EF064205.1
CT13 <i>Bacillus pumilus</i>	<i>Bacillus pumilus</i> strain CT13	EU660365.1
NBRAJATR9 <i>Bacillus subtilis</i>	<i>Bacillus subtilis</i> strain NBRAJATR9	EU661710.1
AU55 <i>Bacillus subtilis</i> str.	<i>Bacillus subtilis</i> strain AU55	EF032684.1
MZ-32 <i>Bacillus subtilis</i>	<i>Bacillus subtilis</i> subsp. <i>subtilis</i> MZ-32	EF422864.1
STM 4035 <i>Agrobacterium</i> s.p	<i>Agrobacterium</i> sp. STM 4035	EF152474.1
RRLJ SMAR <i>Pseudomonas beteli</i>	<i>Pseudomonas beteli</i> strain RRLJ SMAR	DQ299947.1
CL11b <i>Endophytic bacterium</i>	<i>Endophytic bacterium</i> CL11b	EU088087.1
zf-IRht15 <i>Acinetobacter</i> sp	<i>Acinetobacter</i> sp. zf-IRht15	DQ223660.1
H5 <i>Pseudomonas</i> sp	<i>Pseudomonas</i> sp. H5	DQ268826.1
ATCC 12633 <i>Pseudomonas putida</i>	<i>Pseudomonas putida</i> strain ATCC 12633	AF094736.1
NBRAJG91 <i>P. aeruginosa</i> strain	<i>Pseudomonas aeruginosa</i> strain NBRAJG91	EU661707.1

irradiation and secure the spring source in order to supply safe water free of any contamination.

Conclusions

The major conclusions of the study were as follows:

1. The lowest HPC count was recorded in week 46 but

still notably exceeded the maximum limit of < 100 microorganisms/ml (South African National Standards for Bottled Water, 2003).

2. The total cell counts obtained by the FCM method were higher in week 46 at all the sites throughout the period, when compared to the heterotrophic plate counts.

3. The higher FCM counts indicated that the flow cytometry technique was able to detect cells in the sample that enter a viable but non-culturable state and

Table 3. Table of 43 isolates, their codes and accession numbers for organisms isolated from week 8 sampling period.

Name presented on tree	Organism	Accession number
NBRAJG91 <i>P. aeruginosa</i>	<i>Pseudomonas aeruginosa</i> strain NBRAJG91	EU661707.1
NBRAJG91 <i>P. aeruginosa</i>	<i>Pseudomonas aeruginosa</i> strain NBRAJG91	EU661707.1
WW5 <i>Pseudomonas</i> sp.	<i>Pseudomonas</i> sp. WW5	EF433547.1
CMG586 <i>Pseudomonas aeruginosa</i>	<i>Pseudomonas</i> strain CMG586	EU194236.1
418 <i>Pseudomonas</i> sp	<i>Pseudomonas</i> sp. 418	EU841539.1
MCCB <i>Pseudomonas aeruginosa</i>	<i>Pseudomonas aeruginosa</i> isolate MCCB	EF053508.2
IL1 <i>Pseudomonas aeruginosa</i>	<i>Pseudomonas aeruginosa</i> isolate IL1	DQ989211.2
8.2 <i>Pseudomonas</i> sp	<i>Pseudomonas</i> sp. 8.2	EF426444.1
<i>Pseudomonas aeruginosa</i>	<i>Pseudomonas aeruginosa</i>	EU327890.1
634 <i>Comamonas aquatica</i>	<i>Comamonas aquatica</i> strain 634	EU841530.1
K107 <i>Proteus</i> sp	<i>Proteus</i> sp. K107	EU710747.1
<i>Proteus mirabilis</i>	<i>Proteus mirabilis</i>	DQ777867.1
<i>Hafnia alvei</i> CCUG 429	<i>Hafnia alvei</i> CCUG 429	FM179944.1
NJ-64 <i>Enterobacter</i> sp	<i>Enterobacter</i> sp. NJ-64	AM421983.1
MB-1-6-6 <i>Enterobacter</i> sp.	<i>Enterobacter</i> sp. MB-1-6-6	EU816586.1
45 <i>Stenotrophomonas</i> sp	<i>Stenotrophomonas</i> sp. 45	AY856845.1
R551-3 <i>Stenotrophomonas maltop.</i>	<i>Stenotrophomonas maltophilia</i> R551-3	CP001111.1
7-3 <i>Stenotrophomonas</i> sp.	<i>Stenotrophomonas</i> sp. 7-3	EU054384.1
<i>Amorphomonas oryzae</i> B46	<i>Amorphomonas oryzae</i> B46	AB233493.1
TG8 Uncultured soil bacterium	Uncultured soil bacterium clone TG8	DQ297948.2
<i>Rhizobium soli</i> strain DS-42	<i>Rhizobium soli</i> strain DS-42	EF363715.1
NASA2-43 <i>Brevibacterium</i> sp.	<i>Brevibacterium</i> sp. NASA2-43	EU029632.1
<i>Arthrobacter</i> sp. W17	<i>Arthrobacter</i> sp. W17	EU596424.1
SS-08 <i>Staphylococcus pasteurii</i>	<i>Staphylococcus pasteurii</i> strain SS-08	EU624447.1
AT2 <i>Staphylococcus epidermidis</i>	<i>Staphylococcus epidermidis</i> strain AT2	EU021221.2
SA6 <i>Staphylococcus</i> sp	<i>Staphylococcus</i> sp. SA6	AY864655.1
TG8 Uncultured soil bacterium	Uncultured soil bacterium clone TG8	DQ297948.2
BMP-1 <i>Bacillus</i> sp.	<i>Bacillus</i> sp. BMP-1	DQ371431.1
<i>Bacillus</i> sp. X5	<i>Bacillus</i> sp. X5	EU236728.1
WS7b <i>Endophytic bacterium</i>	<i>Endophytic bacterium</i> WS7b	EU088038.
<i>Gamma proteobacterium</i> BDA453	<i>Gamma proteobacterium</i> BDA453	AB304258.1
<i>S. arcachonense</i> sp. nov.	<i>S. arcachonense</i> sp. nov.	Y11561.1
HNR07 <i>Bacillus</i> sp.	<i>Bacillus</i> sp. HNR07	EU373351.1
770 <i>Bacillus cereus</i>	<i>Bacillus cereus</i> strain 770	EU430093.1
SS-07 <i>Bacillus cereus</i>	<i>Bacillus cereus</i> strain SS-07	EU624445.1
BGSC 6A16 <i>Bacillus cereus</i>	<i>Bacillus cereus</i> strain BGSC 6A16	AY310302.1
PSA38 <i>Bacillus cereus</i>	<i>Bacillus cereus</i> strain PSA38	EU346663.1
PK-2 <i>Bacillus</i> sp	<i>Bacillus</i> sp. PK-2	EU685821.1
ZZ2 <i>Bacillus</i> sp.	<i>Bacillus</i> sp. ZZ2	DQ113449.1
SCB001 <i>Bacillus cereus</i>	<i>Bacillus cereus</i> strain SCB001	DQ466089.1

that the heterotrophic plate count technique only allowed for growth of the viable and culturable cells present in the water samples.

4. Flow cytometry proved to be a rapid and more reliable technique for the assessment of total bacterial count in water samples.

5. The dominant species *Pseudomonas* sp. and *Bacillus*

sp. were isolated throughout the sampling period from week one to week 46. The pathogenic organisms isolated from all the sampling periods included *Escherichia* sp., *Pseudomonas* sp., *Shigella boydii*, *Bacillus* sp. and *Staphylococcus* sp.

6. It is thus important to understand quantitatively the viable bacterial load and the species diversity in the

Table 4. Table of 13 isolates, their codes and accession numbers for organisms isolated from week 46 sampling period.

Name presented on tree	Organism	Accession number
ZH4 <i>Bacillus</i> sp	<i>Bacillus</i> sp. ZH4	EU236750.1
BGSC <i>Bacillus cereus</i> strain	<i>Bacillus cereus</i> strain BGSC	AY310302.1
PSA38 <i>Bacillus cereus</i>	<i>Bacillus cereus</i> strain PSA38	EU346663.1
CT13 <i>Bacillus pumilus</i>	<i>Bacillus pumilus</i> strain CT13	EU660365.1
S8-07 <i>Bacillus pumilus</i>	<i>Bacillus pumilus</i> strain S8-07	EU620415.1
JS-12 <i>Bacillus</i> sp	<i>Bacillus</i> sp. JS-12	EF040535.1
YIM KMY42-2 <i>Brevundimonas</i> sp	<i>Brevundimonas</i> sp. YIM KMY42-2	DQ358649.1
B4 <i>Escherichia</i> sp	<i>Escherichia</i> sp. B4	EU722735.1
WW7 <i>Aeromonas</i> sp	<i>Aeromonas</i> sp. WW7	EF433549.1
CN015 <i>Pseudomonas putida</i>	<i>Pseudomonas putida</i> strain CN015	EU364531.1
NBRAJG91 <i>P. aeruginosa</i>	<i>Pseudomonas aeruginosa</i> strain NBRAJG91	EU661707.1
PR <i>Pseudomonas</i> sp	<i>Pseudomonas</i> sp. PR	EU816382.1
CL13A <i>Endophytic bacterium</i>	<i>Endophytic bacterium</i> CL13A	EU088094.1

bottling water distribution system in order to apply and optimize the most efficient sanitization procedure.

7. As bottled water cannot be subjected to any chemical treatments during and after bottling it is also important to understand the survival capacity of the pathogenic and indicator organisms.

ACKNOWLEDGEMENTS

The National Research Foundation (NRF) and Cape Peninsula University of Technology (CPUT) for financial support.

Abbreviations: **HPC**, Heterotrophic plate count; **FCM**, flow cytometric analysis; **rRNA**, ribosomal ribonucleic acid; **PCR**, polymerase chain reaction; **UV**, ultraviolet; **CFU's**, colony forming units; **TAE**, tris-acetate- ethylenediamine tetraacetic acid; **ANOVA**, analysis of variance; **RMA**, repeated measures ANOVA.

REFERENCES

- Altschul SF, Madden TL, Schäffer AA, Zhang J, Zhang Z, Miller W, Lipman DJ (1997). "Gapped BLAST and PSI-BLAST: a new generation of protein database search programs". *Nucl. Acids Res.*, 25: 3389-3402.
- Beuret C, Kohler D, Baumgartner A (2002). Norwalk-likevirus sequences in mineral waters: One year monitoring of three brands. *Am. Soc. Microbiol.*, 68: 1925-1931.
- Dunn OJ, Clark VA (1987). *Applied Statistics: Analysis of variance and regression* (2nd Ed.) John Wiley & Sons. London, UK.
- Ehlers MM, Van Zyl WB, Pavlov DN, Muller EE (2004). Random survey of the microbial quality of bottled water in South Africa. *Water SA*, 30(2): 203 – 210.
- Greisen K, Loeffelholz M, Purohit A, Leong D (1994). PCR primers and probes for the 16S rRNA gene of most species of pathogenic bacteria, including bacteria found in cerebrospinal fluid. *J. Clin. Microbiol.*, 32: 335-351.
- Guidelines for Canadian Drinking Water Quality (2008). Treatment Technology. mhtml:file:E:\articles\Page9 [Accessed 30 April 2004].
- Javois LC (1999). *Immunocytochemical Methods and Protocols*. Totawa, NJ: Human Press. <http://www.answers.com/topic/flow-cytometry> [Accessed 27 August 2007].
- Leclerc H (2002). Microbiology of Natural Mineral Waters. <http://www.centre-evian.com/fondDoc/dos-science/11858.html> [Accessed 18 September 2003].
- Leclerc H, Moreau A (2002). Microbiological safety of natural mineral water. *FEMS Microbiol. Rev.*, 26(2): 207-222.
- Pall Filters™. (2004). *Focus on filtration*.
- Paulse AN, Jackson VA, Khan W (2007). Comparison of enumeration techniques for the investigation of bacterial pollution in the Berg River, Western Cape, South Africa. *Water SA*, 33: 165-173.
- Percival SL, Knapp JS, Edyvean GJ, Wales DS (1998). Biofilms, mains water and stainless steel. *Water Res.* 32(7): 2187-2201.
- Ray B (2004). *Fundamental Food Microbiology*. 3rd ed. CRC Press: Florida, 374.
- Ryan KJ (2004). *Medical Microbiology*. 4th ed. Mc Graw Hill: New York, USA.
- Saitou N, Nei M (1987). The neighbour-joining method: a new method for reconstructing phylogenetic trees. *Mol. Biol. Evol.*, 4: 406-425.
- Senior D, Dege N (2005). *Technology of bottled water*. Blackwell Publishing Ltd, Oxford, UK.
- Sommer R, Cabaj A (1993). Evaluation of the efficiency of a UV plant for drinking water disinfection. *Water Sci. Technol.*, 27: 357-362.
- South Africa, Department of Health (2004). *Foodstuffs, Cosmetics and Disinfectants Act: Act 54 of 1972*. Regulations governing bottled waters including natural mineral waters. Pretoria: Government Printer: No R 502.
- South African National Standards (2003). *Bottled Natural Water*. SANS 1657:2003 Ed 1.3. Notice 1373 of 8 November 2002.
- Tamura K, Dudley J, Nei M, Kumar S (2007). *MEGA4: Molecular Evolutionary Genetics Analysis (MEGA) software version 4.1*. *Mol. Biol. Evol.*, 24: 1596-1599.
- Tsen HY, Lin CK, Chi WR (1998). Development and use of 16S rRNA gene targeted PCR primers for the identification of *Escherichia coli* cells in water. *J. Appl. Microbiol.*, 85: 554-560.
- World Health Organisation (1996). *Guidelines for drinking water quality* 2nd (ed). Weiner Verlag, WHO, Austria.