

*Full Length Research Paper*

# **The discovery teaching of the problem of finding the shortest distance with the help of Geogebra software in Vietnam**

**Ngoc-Giang Nguyen**

Department of Economic Mathematics, Banking University of Ho Chi Minh City, 36 Ton That Dam, Nguyen Thai Binh Ward, District 1, Ho Chi Minh City, Vietnam.

Received 24 June, 2021, Accepted 23 July, 2021

Vietnam today is having solid innovations in the fields of science, technology, economics, and education. In particular, the Mathematical General Education program launched in 2018 has emphasized the exploitation of information technology in teaching. GeoGebra software is taught right from the 6th grade. GeoGebra software has many advantages in problems related to motion such as locus, modeling, and especially in finding the shortest path. We have found that the discovery teaching method proves to have outstanding advantages in teaching this shortest path problem. Our research focus on understanding the perspectives of discovery teaching, the discovery teaching process, the pros and cons of the discovery teaching method, illustrating the application of GeoGebra software in the discovery teaching of finding the shortest distance. Using essential research methods such as theoretical research, investigation, survey, and descriptive statistics with the help of SPSS version 20 software for 49 students grade 12th, we found that students felt very interested in the new teaching method. Students showed excitement and enthusiasm in lessons to find the shortest distance with the help of GeoGebra software. The assessment results show that students make more progress when applying GeoGebra to teaching than traditional teaching methods.

**Key words:** Discovery teaching, shortest distance, GeoGebra.

## **INTRODUCTION**

Discovery teaching is a learner-centered teaching method (Le, 2007; Nguyen, 2014). Learners only really progress and develop when they participate in knowledge construction themselves (Tran, 2003). They build their knowledge through practical experience activities.

Learning is a sequence of active learner activities (Nguyen, 2007). Based on students' knowledge base, teachers guide and supplement rather than impose knowledge. Through these guiding and supporting activities, students form understanding. Discovery

E-mail: [nguyennngocgiang.net@gmail.com](mailto:nguyennngocgiang.net@gmail.com).

Author(s) agree that this article remain permanently open access under the terms of the [Creative Commons Attribution License 4.0 International License](https://creativecommons.org/licenses/by/4.0/)

teaching is a process, not an outcome. It is not a rigid, dogmatic, immutable teaching method (Tran, 2004). Discovery teaching helps students to drill down and solve problems better in real-life situations. Teaching activities of this method are divergent. Students are not the ones who answer the questions by heart. They must explore, observe and draw new knowledge by themselves (Phan, 2013). These ones will start from a task of teaching to exploit and transform to expand their knowledge gradually. Learners will slowly dissect knowledge units. After that, it will be aggregated to obtain substantive results. In particular, the discovery teaching method proves to be effective when working in groups or applying information technology to teaching. Information technology activities require students to self-study problems, analyze problems, explain and clarify issues in learning. These activities are the advantages of information technology in general and GeoGebra software in particular (GeoGebra, 2021). Thanks to the advantage of dynamic geometry software, GeoGebra software can build, move, create traces, predict results, verify, discover solutions that the results are known immediately, so it is very effective to apply in the problem of finding the shortest distance. Students can rely on the results found on GeoGebra software to draw their results. From the prediction results on GeoGebra software, learners rely on that, mobilizing their available knowledge and experience to find the solution themselves. This learning process is "reversed" learning. Instead of starting from the original data, learners find a solution for it and then draw the conclusion of the problem; now, learners do the opposite. It is a new feature in teaching, but teaching methods with traditional tools such as blackboards, white chalk, rulers, and compasses can hardly do. From the above comments, in this article, we focus on answering the following four questions:

1. What are some of the views and concepts about discovery teaching?
2. What are the advantages and disadvantages of discovery teaching?
3. What are the steps involved in the discovery teaching process with the help of GeoGebra software?
4. What are the specific examples of the application of GeoGebra software in discovery teaching to find the shortest distance?

## METHODOLOGY

Discovery teaching is a teaching method based on constructivism. Learners participate in open hands-on activities to solve real-life problems. Learners connect new information with existing knowledge in an organized and systematic way. This learning requires learners to mobilize higher-order thinking (Rooney, 2009). This one is a student-centered approach. This way of teaching both

improves students' learning outcomes and develops higher-order skills. If teachers aim for a strong link between teaching and research, then teachers should adopt a discovery teaching method. The method is the process of seeking new knowledge and understanding (Spronken-Smith and Walker, 2010). It plays an essential and active role in student learning. This way of teaching creates curiosity, imagination and encourages students to interact and explore knowledge and science through experiential activities (Harlen, 2013).

Discovery teaching is a form of teaching in which students engage in learning activities, solve unsolved problems, and construct, analyze, and debate mathematical arguments. From there, students draw new knowledge on their own (Laursen et al., 2014). In this one, learners engage in problem-solving activities as experts. They collaboratively discover with others in an environment without or with very little guidance and support from the teacher. (Kirschner et al., 2004). This method is one of the modern and active forms of teaching that helps students make the right decisions and apply scientific knowledge to solve problems. It is the best way to gain scientific understanding because it allows students to discuss and debate scientific ideas. It is how scientists practice, evaluate ideas and draw conclusions (Gormally et al., 2009).

In discovery teaching, students will learn content such as knowledge, skills, and reasoning by actively participating in meaningful research, interpreting, and communicating their ideas. Teachers play an important role in facilitating this learning process and providing content knowledge when needed (Hmelo-Silver et al., 2007). This method is a practical method for establishing connections between prior knowledge and scientific descriptions of the natural world. Students should be allowed to understand how to do scientific research (Panasan and Nuangchalem, 2010). This one helps students explore mathematical problems, propose and test conjectures, develop proofs or solutions, and explain students' ideas. As students learn new concepts through debate, they also see math as a creative human endeavor to contribute. It is consistent with the socio-constructive view of learning. It emphasizes the construction of personal knowledge supported by social interactions (Kogan and Laursen, 2014).

Discovery teaching increases practice time, reduces theoretical discussion, and helps improve critical thinking. This method has positive effects, assisting students to gain a deep understanding and achieve high academic achievement (Friesen and Scott, 2013). The one has many different perspectives and research directions. This method is distinguished by the type and complexity of problems and the degree of student-centered learning (Schoenfeld and Kilpatrick, 2013). It is an active teaching method. Students are given a carefully choreographed mathematical task sequence and asked to solve and understand them, either individually or in groups (Ernst et al., 2017).

Discovery teaching promotes positivity in science and math education. The one is a teaching method that fosters necessary competencies and attitudes for everyone in today's increasingly technology-based society (Harlen, 2013). This method is an approach to teaching that offers research-intensive learning opportunities. The one guides students to explore or reinvent essential math concepts through carefully formulated tasks. This teaching method requires students to have the habit of thinking like a practicing mathematician, developing the ability to guess, experiment, create, and communicate. Therefore, discovery teaching develops the critical process, supporting in-depth research on the topic to be explored. It can promote persistence, independence, and creative application of mathematical knowledge in practice (Laursen et al., 2015). It is the ability to think and work scientifically and is encouraged by science and education leaders

worldwide. Scientifically minded people are important to science, technology, and society because they are always curious, always trying to understand the world around them, and become lifelong learners. Therefore, education must be taught to allow students to make personal, social, and economic decisions. It is the most appropriate teaching method for this claim (Madhuri et al., 2012).

Discovery teaching is a teaching method in which students actively explore information by applying scientific discoveries to real-life contexts. The one is how students approach the natural world through questions, tasks, tests, and assessments to gain a new understanding. Students create knowledge by activating and restructuring knowledge. The exploratory learning environment also requires students to be active in the learning and interacting process (De Jong, 2006). This method not only helps learners discover new knowledge but also helps students develop creative thinking (Vu, 2017). Students' discovery activity in learning is not a spontaneous process but a cognitive approach with the guidance of teachers to capture human knowledge (Le, 2017).

Discovery activity in discovery teaching is not a groping process like scientific researchers but a process of exploratory activities with the guidance of teachers. The teacher skillfully puts the student in the position of the rediscoverer of knowledge. Teachers do not give presentations to students directly, but students must acquire new knowledge through experiential activities (Tran, 2011). Discovery teaching emphasizes ways to find new knowledge based on old knowledge and experiences of students. It emphasizes the learning process, not the learning outcomes. Students acquire knowledge on their own through teacher's activities. Questions and questioning are essential elements of discovery teaching. The result of this one is that students develop knowledge and skills and grasp the methods of acquiring the knowledge and skills (Le, 2012).

From the points of view of the above, we draw a brief comment. Discovery teaching is a teaching method based on constructivism. It is an active and student-centered teaching method. Learners in this one must always acquire new knowledge by themselves through questions and the teacher's guidance. It is a teaching method that emphasizes the whole learning process, not just the learning outcome. Learners learn knowledge, skills, and promote progressive attitudes and learn how to get to those knowledge, skills, and attitudes.

## RESULTS

### Advantages and limitations of discovery teaching

Discovery teaching is an active teaching method. It is a teaching method that promotes the potential of the learners.

However, this method also has certain advantages and limitations.

#### Advantages

1. Pleasure and satisfaction in finding out something for yourself that you want to know;
2. Gaining knowledge by yourself is more effective than being taught directly by a teacher;
3. Stimulate curiosity about the world around;
4. Develop newer and bigger ideas about the world

around you;

5. Develop the necessary skills in scientific research through participation in it;
6. Realize that scholarly learning involves discussing, working with, and learning from others or through documentation;
7. To understand the discovery problem, the discoverer must make an effort (Harlen, 2013).

#### Limitations

1. Potentially confusing students if they do not have an initial knowledge base.
2. There are practical limitations when schools do not consider it the primary teaching method for learning lessons.
3. Spending much time doing lesson activities (e.g., math activities), so there won't be enough time for students to "discover" everything during the student's school year.
4. Requires teachers to prepare many things for correcting, lots of feedback on students making mistakes (trial and error process).
5. It can become a barrier because of many essential skills and essential information that all students should learn.
6. If discovery teaching is implemented as the most crucial educational theory, there will be a tendency to create an incomplete education.
7. Discovery teaching in the traditional classroom is only possible with a small number of students, not interacting with students in different geographical areas, such as students in this province, another province, or this country, the other country. Therefore, the interactive environment in traditional discovery teaching is limited.
8. Discovery teaching in traditional classrooms with many students does not have enough experts to assist in the immediate response phases. When students choose the wrong option, traditional discovery teaching does not immediately provide additional information or guidance.
9. Traditional discovery teaching often requires a teacher to perform the teaching phase. Students explore according to the activities and requirements of the teacher (Nguyen, 2016).

### Discovery teaching process with the help of GeoGebra software

Based on the discovery teaching process proposed by Levy and Petrulis (2012), including identifying, pursuing, producing, and authoring steps, we offer the discovery teaching process with the help of GeoGebra software as follows:

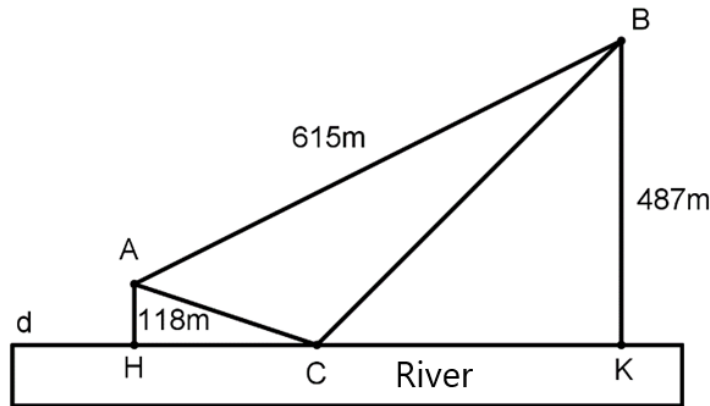

Figure 1. The minimum distance (Personal Collection) (Trinh, 2020).

**Step 1. Identify the problem to be discovered with the use of GeoGebra software**

Teachers ask questions and ask students to use GeoGebra software actively to explore solutions.

**Step 2. Build shapes on GeoGebra software**

Students build shapes on GeoGebra software, move points and objects to different positions. From there, we find the results as well as verify the students' predictions.

**Step 3. Solve the math**

From the prediction results on GeoGebra software, we draw the corresponding solution.

**Step 4. Conclusion**

Conclude problem solutions.

**Step 5. Deepen the problem**

Find many ways to solve the problem, expand the problem, and find out similar issues with the problem being discovered, thereby forming new results and new problems.

**Example illustrating the application of GeoGebra software in discovery teaching of finding the shortest distance**

**Example 1**

There are two locations, A and B, on the same side of the

riverbank  $d$  as shown in Figure 1. The distance from A to the riverbank is 118m, and the distance from B to the riverbank is 487m. In addition, the distance between A and B is 615m. A person goes from location A to the riverbank (A, B side) to get water and then goes back to position B. What is the minimum distance that person goes from A to B (with stops by the riverbank)? (unit m).

Generalizing Example 1, we get the following Héron problem:

**Example 2 (Héron Problem)**

In the plane, given a line  $d$  and two points A and B on the same side of the line. On the given line, find a point C such that the sum of the distances from that point C to two points A and B is the smallest (Nguyen et al., 2020).





In the following, we will use GeoGebra software in discovery teaching to solve this shortest path problem.

**Step 1. Identify the problem to be discovered with the help of GeoGebra software**

Teacher: Please build the shape and find point C, so that  $CA + CB$  is the smallest on GeoGebra software.

**Step 2. Build the shape on GeoGebra software**

Students:

1. Construct a straight line  $d$ :  Line
2. Draw point A and point B on the same side with  $d$ :  A Point
3. Draw point C on the line  $d$ :  A Point
4. Connect CA, CB:  Segment

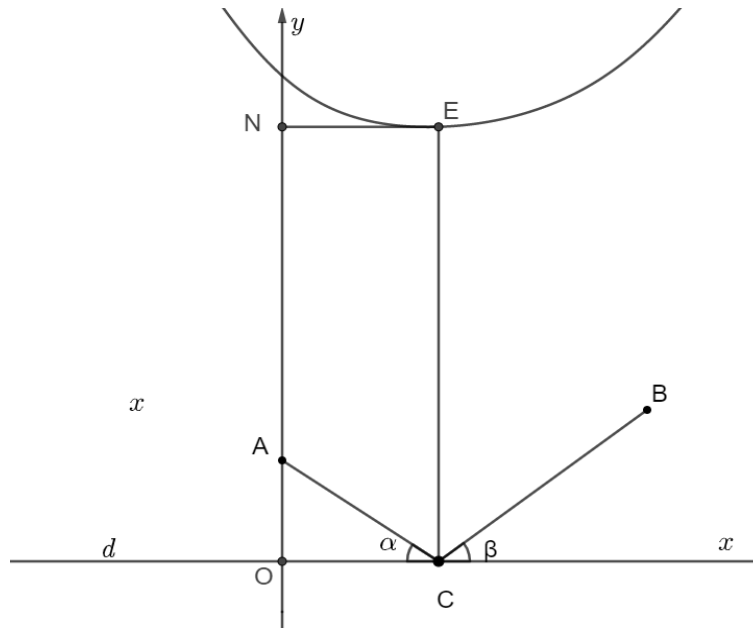
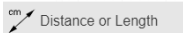
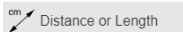

Figure 2. Graph of Héron problem (Personal Collection).

5. Measure the length of the line segments  $CA, CB$ :



6. Measure the total length of the line segments  $CA + CB$ :



7. Construct a system of perpendicular axes  $O_{xy}$ , so that  $O_y$  contains  $A$  and  $O_x$  belongs to  $d$ .

8. Draw on  $O_y$  a point  $N$  so that  $ON$  is equal to the sum of the lengths of the line segments  $CA + CB$ .

9. Suppose  $E$  is the intersection of the line perpendicular to  $O_y$  at  $N$  and the line perpendicular to  $O_x$  at  $C$  (coordinates of point  $E$  represent the sum of the lengths of the line segments  $CA + CB$ ).

10. Create a trace for  $E$ , move  $C$  we get a trace of point  $E$  (Nguyen, 2019).

Teacher: The outstanding advantage that GeoGebra

dynamic geometry software has, but cannot be done by ordinary mathematical thinking, is that we can move point  $C$  on  $d$  so that the coordinates of point  $E$  reach the minimum value. Now through observation, we see that the angles  $ACd$  and  $BCx$  are equal (Figure 2).

**Step 3. Solve the math**

Teacher: We denote distances and angles as shown in Figure 3.

When  $(CA + CB)_{\min}$ ,

then  $\alpha = \beta$ ,

$\tan \alpha = \tan \beta$ .

What relation do you get?

Students:  $\tan \alpha = \tan \beta \Leftrightarrow \frac{a}{x} = \frac{b}{c-x} \Leftrightarrow ac = (a+b)x \Leftrightarrow x = \frac{ac}{a+b}$ .

Teacher: Now  $(CA + CB)_{\min} = ?$

Students:  $(CA + CB)_{\min} = \sqrt{a^2 + \left(\frac{ac}{a+b}\right)^2} + \sqrt{b^2 + \left(c - \frac{ac}{a+b}\right)^2} = \sqrt{c^2 + (a+b)^2}$ .

Teacher: Prove that for every point  $C$ ,  $CA + CB$  is always  $(CA + CB)_{\min} = \sqrt{a^2 + (b+c)^2}$  ?

greater than or equal to Students: We will prove:

$$\begin{aligned} & \sqrt{a^2 + x^2} + \sqrt{b^2 + (c - x)^2} \geq \sqrt{(a + b)^2 + c^2} \\ \Leftrightarrow & a^2 + x^2 + b^2 + c^2 - 2cx + x^2 + 2\sqrt{(a^2 + x^2)(b^2 + (c - x)^2)} \geq a^2 + b^2 + c^2 + 2ab \\ \Leftrightarrow & \sqrt{(a^2 + x^2)(b^2 + (c - x)^2)} \geq ab + x(c - x) \\ \Leftrightarrow & a^2b^2 + a^2(c - x)^2 + x^2b^2 + x^2(c - x)^2 \geq a^2b^2 + x^2(c - x)^2 + 2abx(c - x) \\ \Leftrightarrow & a^2(c - x)^2 + x^2b^2 \geq 2abx(c - x) \\ \Leftrightarrow & (a(c - x) - bx)^2 \geq 0. \end{aligned}$$

Teacher: So building shapes on GeoGebra gives us an important mathematical approach that we would not usually be able to do. That is, it is possible to create a trace for point  $E$ . From the trace of point  $E$ , we can move point  $C$  to a position so that the coordinates of point  $E$  are the smallest. From moving point  $C$  so that the coordinates of point  $E$  are the smallest, we will infer how to solve the problem. Like it or not, this is always a great mathematical thought. It gives us immediate access to the results. From the result, we will deduce the solution. Obviously, this is a bit of a paradox. But the paradox makes perfect sense thanks to the development of informatics. This teaching method is also known as

reverse teaching (Nguyen, 2019).

Teacher: When  $\alpha = \beta$ , let  $A'$  be the symmetry point of  $A$  through  $d$ , we will have  $A', C, D$  collinear. From this comment, draw the result of example 1 (Figure 4):

Students:

Let  $A'$  be the point of symmetry of  $A$  with respect to  $d$ . Let the intersection of the line through  $A'$  perpendicular to  $AA'$  and  $BK$  be  $B'$ . Let  $C$  be a point in  $HK$ . Then we have  $AC + CB = CA' + CB \geq A'B$ .

Hence:

$$\begin{aligned} (AC + CB)_{\min} &= A'B \\ &= \sqrt{BB'^2 + A'B'^2} \\ &= \sqrt{(BK + HA')^2 + AB^2 - (BK - AH)^2} \\ \Rightarrow A'B &= \sqrt{(487 + 118)^2 + 615^2 - (487 - 118)^2} \\ &= \sqrt{608089} \approx 779,800612m. \end{aligned}$$

#### Step 4. Conclusion

So the minimum distance that person goes from  $A$  to  $B$  (with a stop at the river bank) is **779,800612m**.

#### Step 5. Deepen the problem

Teacher: In addition to mathematical solutions, the Héron problem has many other solutions.

Students: Listen and absorb ideas (Figure 5).

Teacher:

##### Solution 2

Moving along the curved line  $ACB$  can be considered light traveling from  $A$  to "flat mirror"  $d$  (line  $d$  acts as a flat mirror); after reflecting on the mirror, the reflected ray passes through point  $B$ .

According to the law of light reflection, we immediately get the solution of the problem when  $C$  coincides with  $C'$ . Now  $AC'N = NC'B$  (Nguyen, 2019).

This solution shows the physical nature of the mathematical problem. However, this is not the only physical solution. We can solve this problem by other physical methods as follows:

##### Solution 3

We consider a weightless  $C$  ring that can slide without friction along a horizontal  $d$ -axis. At the  $C$  end, there are two threads connected. Each of these threads loops around a pulley (at  $A$  and  $B$ , respectively), and at the other end of the thread hang heavy objects of the same mass  $C_1$  and  $C_2$  respectively (Figure 6). We also

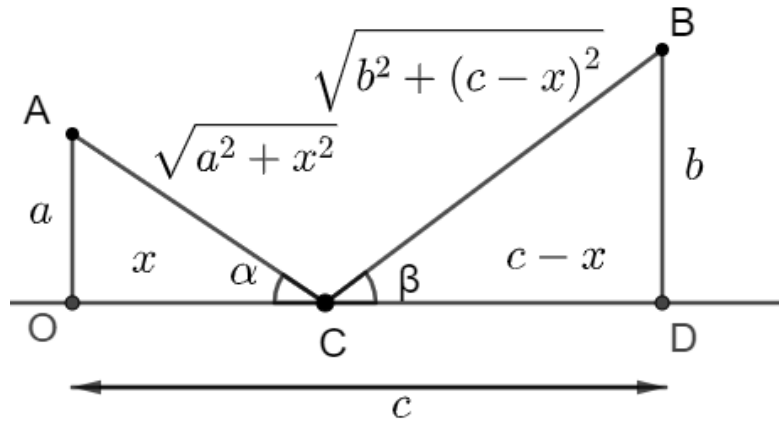

Figure 3. Mathematical solution (Personal Collection).

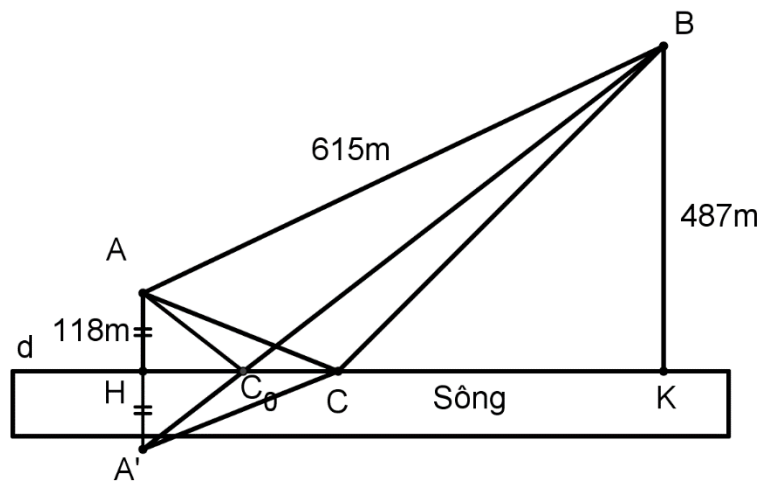

Figure 4. Real solution (Personal Collection).

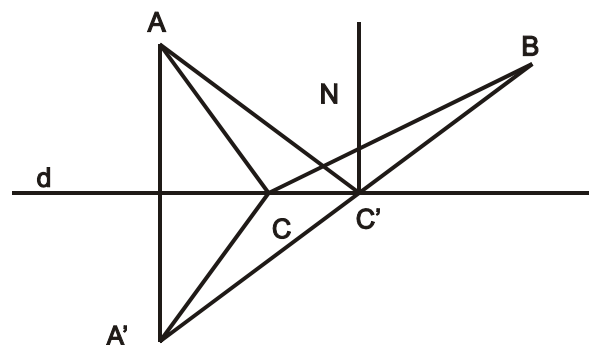

Figure 5. Solution by the law of light reflection (Personal Collection).

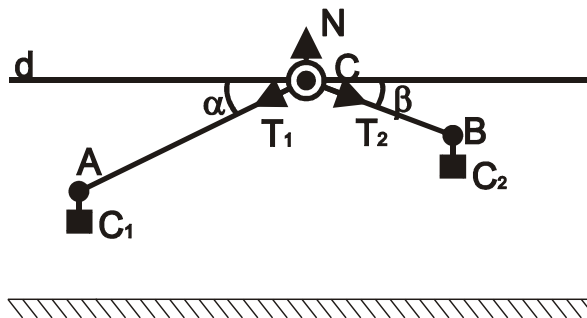

Figure 6. Mechanical solution (Personal Collection).

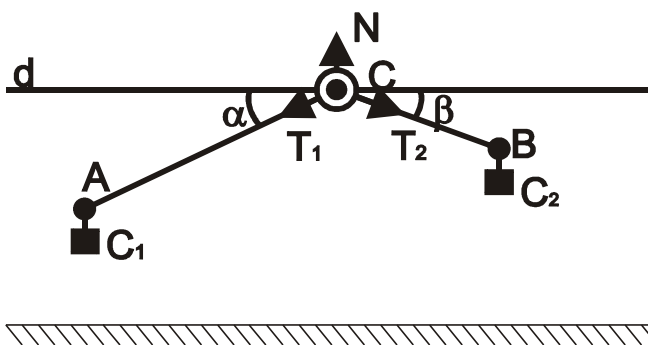

Figure 7. Tension forces (Personal Collection).

assume the usual simplification conditions: the shaft is absolutely rigid, threads are absolutely soft but not elongated, regardless of friction, the weight of threads and reaction of their cornering, size of the pulleys, and the ring. We need to find the position of the C-ring on rod  $d$  so that the whole mechanical system is in equilibrium.

Indeed, the two heavy objects must be suspended as low as possible (that is, the system's potential energy must be minimized). Hence it follows that the sum of,  $AC_1 \cdot C_1 + BC_2 \cdot C_2$  must be maximal. Since the length of each string remains the same, the sum of  $AC \cdot C_1 + BC \cdot C_2$  must be minimized.

At the equilibrium position of the system, the forces acting on the ring C are zero. Therefore, C is subjected to the tension forces of the threads  $\vec{T}_1$  and  $\vec{T}_2$  ( $|\vec{T}_1| = |\vec{T}_2|$  - (the heavy objects pull the threads with equal forces, the tension due to the weights is not reduced by friction in the pulleys but is transmitted completely) and reaction  $\vec{N}$  (Figure 7).

Since  $\vec{N} + \vec{T}_1 + \vec{T}_2 = \vec{0}$  and  $\vec{N} \perp d$ , the projection on the line  $d$  gives us  $|\vec{T}_1| \cos \alpha = |\vec{T}_2| \cos \beta$ , from which

$\alpha = \beta$ . We also get the same result as solution 1.

Here, we need to explain more why we project  $\vec{N} + \vec{T}_1 + \vec{T}_2 = \vec{0}$  onto the line  $d$  ( $\vec{N} \perp d$ ) and get the relation  $|\vec{T}_1| \cos \alpha = |\vec{T}_2| \cos \beta$ . Because the tension forces cannot pull the ring back vertically because the  $d$  axis passes through the absolutely rigid ring (the reaction  $\vec{N}$  of the shaft can be of arbitrary magnitude), in addition, the horizontal component forces of those two forces, having opposite directions, must cancel each other out, must be equal in magnitude. Or we have the relation  $|\vec{T}_1| \cos \alpha = |\vec{T}_2| \cos \beta$ . It coincides with the argument above) (Nguyen, 2019).

Teacher: After explaining the Héron problem with methods in different fields, we realize one thing: mathematics is beautiful. Mathematics, informatics, and physics are not separate from each other but are closely linked, dialectically not separate. One area illuminates the other and vice versa.

Teacher: Extend point C to the line segment CD moving on  $d$ . Please state this extended problem.



Students: Give the extended problem.

**Example 3** (Generalization of the Héron problem)

Given two fixed points, A and B lie on the same side of the line d. The segment CD on the line d has a constant length and moves along this line. Find the position of CD so that the perimeter of the quadrilateral ABCD is the smallest.

This problem is a generalization of the Héron problem. Does it have anything to do with the Héron problem? Can we turn this problem into a Héron problem? The answer is yes. Before going to the solution closely related to the Héron problem in the following section, we build the model on GeoGebra software to find the position CD on d so that the perimeter of quadrilateral ABCD is minimal. Since the perimeter of quadrilateral ABCD is the smallest if and only if CA + DB is the smallest, we construct the following:



Step 1. Identify the problem to be discovered with the help of GeoGebra software.

Teacher: Build the shape and find the points C and D so that CA + DB is the smallest on GeoGebra software?

Step 2. Build the shape on GeoGebra software

Students:

Step 1. Build the shape

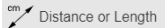
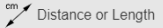
- Construct a straight line d: 
- Construct a line segment CD of constant length sliding over d: 
- Construct two points A and B on the same side of the line d: 
- Connect CA, BD.
- Measure the length of the line segments CA, DB: 
- Measure the total length of the line segments CA + DB: 
- Construct a system of perpendicular axes Oxy so that Oy passes through point A and Ox lies on line d.
- Construct on Oy a point N so that ON is equal to the sum of the lengths of the line segments CA + DB.
- Let E be the intersection of the line perpendicular to Oy at N and perpendicular to Ox at C (coordinates of point E represent the sum of the lengths of the line segments CA + CB).

Step 2. Make a trace

- Create a trace for E; moving C, we get a trace of point E.

We move point C on d so that the coordinates of point E reach the minimum value. Now through observation, we see that angle ACd and B'Cx are equal (B' is the point so that  $\overline{B'B} = \overline{CD}$ ) (Figure 8).

Step 3. Solve the problem

We see that example 3 and example 2 are closely related. How do we bring example 3 to example 2? We consider the translation  $T_{\overline{DC}} : B \mapsto B', D \mapsto C$ . Now, CA + DB = CA + CB'. So we return to example 2. We have the same solution as for example 2 as follows:

1. Draw point B' so that  $\overline{BB'} = \overline{DC}$ .
2. Connect CA, DB.
3. Let A' be the point of symmetry of A with respect to d. Join A'B and cut d at C'. Connect C'A, C'B'.
4. Draw point D' so that  $\overline{B'B} = \overline{C'D'}$ , then C'D' is the position to be erected.  
 $CA + BD = CA + CB' = CA' + CB' \geq A'B' = A'C' + C'B = C'A + C'B = C'A + D'B$ . (Nguyen, 2019) (Figure 9).

Step 4. Conclusion

So C'D' is the position to be erected.

**DISCUSSION**

**Purpose, requirements, and content of the pedagogical experiment**

**Time, object**

The pedagogical experiment was conducted at Binh Chanh High School (Binh Chanh District, Ho Chi Minh City) for the 2020-2021 school year.

- Experimental class 12A1 includes 24 pupils. Math teacher: Huynh Thi Thanh Binh.
- Control class 12A2 includes 25 pupils. Math teacher: Huynh Thi Thanh Binh

**Experimental process**

Investigate and evaluate the learning situation of students in the experimental class and the control class. Prepare materials and experimental lesson plans. The teacher conducts teaching according to the compiled lesson plan. Monitor learning attitude, test-taking skills, ability to

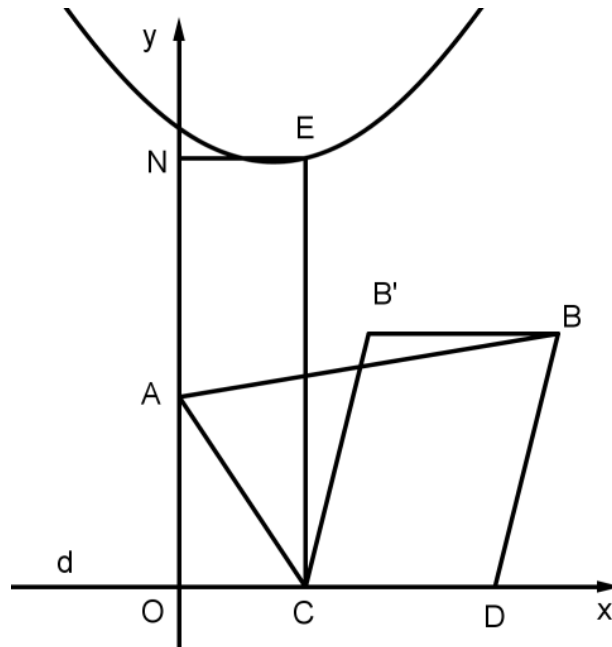

Figure 8. Graph (Personal Collection).

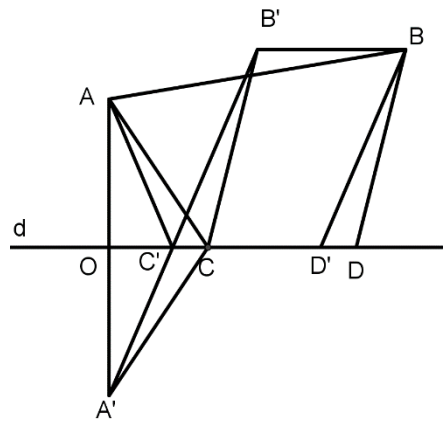

Figure 9. The smallest perimeter (Personal Collection).

receive general knowledge of the whole class. After teaching, the teacher gives the experimental class and the control class a 45-minute test.

**Empirical evaluation method**

We observe the classroom: to receive students' feedback on the lesson about interest, positive attitude, awareness level, and ability to apply. After that, Interview the

students: talk with students to clarify information about the level of interest of measures that are difficult to determine through observation.

In addition, we conduct interviews with teachers to know the teachers' evaluations and comments about the students' interest and awareness levels in the experiment. We give essay test: aims to assess students' ability to acquire knowledge through the lesson. We test individual understanding of the experimental and control classes through a test in the form of an essay after the

**Table 1.** Frequency distribution table of math test scores of two classes (Personal Collection).

		Experimental math test scores										Total
		5.5	6.0	6.5	7.0	7.5	8.0	8.5	9.0	9.5	10.0	
Class	E	0	1	1	4	4	5	4	3	1	1	24
	C	2	3	3	4	4	3	3	2	1	0	25
Total		2	4	4	8	8	8	7	5	2	1	49

**Table 2.** Table of the characteristics parameters of statistics of test scores of two classes (Personal Collection).

Class	Mean	Variance	Std. Deviation
E	7.96	.93	.97
C	7.34	1.27	1.12

experiment.

The content of the test is based on the lesson's objectives according to the lesson plan. We pay special attention to the exercises to evaluate the effectiveness of using the students' ability to detect and solve problems. The scores of the tests are scored on a 10-point scale. Next we use mathematical, statistical method: aims to know the mean, variance, and standard deviation. From there, we know the significance of the numbers through statistics. The statistical software used here is SPSS version 20 software.

In this method, we evaluate the average score of the experimental class and the control class in the first semester, the score of the most recent test before the experiment, and the score of the experimental test on the actual math topic in grade 12 through the following tables.

The first is the score frequency table of the two classes. The second is the histogram of the scores of the two classes. Next, the third is a table of characteristic values (including mean, variance, standard deviation). Finally, the Independent Samples T-Test panel tests whether there is a statistically significant difference between the points in the two classes.

**Analysis of pedagogical experiments**

To test the feasibility and evaluate the effectiveness of the measures, we asked the teacher to conduct a 45-min test for students of the experimental class and the control class. Through a quantitative analysis based on the test results, we obtained the frequency distribution table of experimental math test scores of the experimental class and the control class as follows (Table 1).

We test the normal distribution and find that the distribution of the experimental scores is normally distributed (Chart 1).

From the data in Table 1, we have Chart 2 to compare the scores of the test results of the two classes.

Looking at Chart 2, we can see that the heights of the score columns and the distribution of points of the two classes are different. The scores of the experimental class are from 6.0-10 points or more, and most are 7.0-9.0 points. The score distribution of the control class is from 5.5-9.5 points, and the majority is from 6.0-8.5.

In addition, we also obtain the characteristic parameters of statistics as in Table 2.

Reading the above test results, we have the average score of the two classes:  $\bar{X}_E = 7.96$ ;  $\bar{X}_C = 7.34$ .

Variance:  $S_E^2 = 0.93$ ;  $S_C^2 = 1.27$ .

Comment: There is a big difference between the mean scores of the two classes.

The average score of the experimental class is higher; the experimental class's standard deviation and variance are lower, so the concentration around the mean is higher than that of the control class. Therefore, we can say that the score of the experimental class is higher than that of the control class.

To accurately assess the difference (or the big, small) between the mean scores of the two experimental classes, we test the mean between the two classes, with a significance level  $\alpha = 0,05$  through Table 3 with two the following assumptions:

Assumption  $H_0$ : "The mean scores of experimental and control classes are similar."

$H_1$ : "The average score of the experimental class is higher than that of the control class."

- Levene test has a value of  $Sig. = 0.324 > \alpha = 0,05$ , so the variances of the two classes are almost equal, using the results of the Independent-samples T-test corresponding to the case where the equal variances of

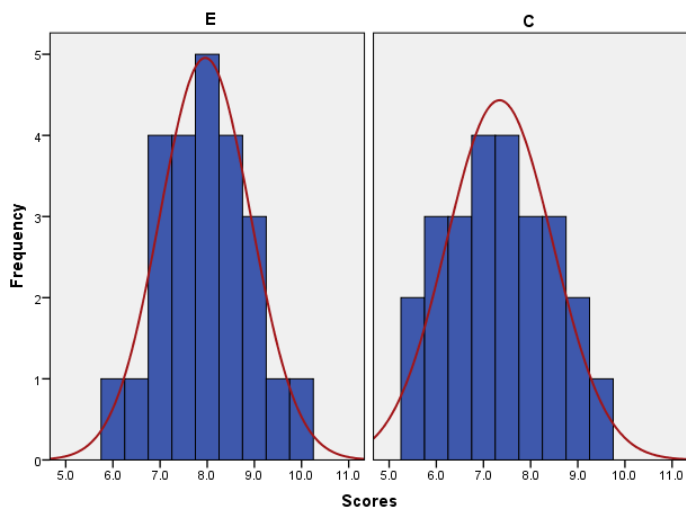

**Chart 1.** Distribution of math test scores of two classes (Personal Collection).

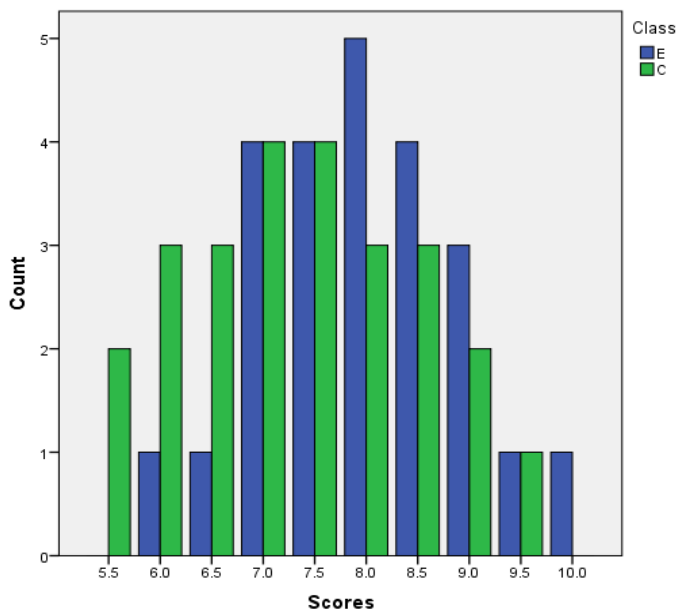

**Chart 2.** Column chart comparing test scores of two classes (Personal Collection).

the two samples are assumed.  
 - Independent-samples T-test, we have  $Sig.(2-tailed) = 0.045 < \alpha = 0.05$ , so we reject hypothesis  $H_0$ , accept hypothesis  $H_1$ . The mean score of the experimental class is higher than that of the control class at the 5% level of significance.

Thus, by the test method between classes with equivalent academic ability, the results show that after being taught according to the experimental lesson plan, the experimental class has better results, the average score is higher than that of the control class. Thus, it can be seen that the experimental measures applied to the

**Table 3.** Average T-test table of test scores of two classes (Personal collection).

		Independent samples test									
		Levene's test for equality of variances		t-Test for equality of means							
		F	Sig.	t	df	Sig. (2-tailed)	Mean Difference	Std. Error Difference	95% Confidence interval of the difference		
										Lower	Upper
Experi-mental test scores	Equal variances assumed	0.995	0.324	2.061	47	0.045	0.6183	0.3001	0.0147	1.2220	
	Equal variances not assumed			2.067	46.440	0.044	0.6183	0.2991	0.0164	1.2203	

experimental class are entirely feasible and effective in teaching.

### CONCLUSION AND RECOMMENDATIONS

In discovery teaching, learners are not passive people. Learners actively explore on their own, ask questions to teachers, and acquire knowledge by themselves.

Discovery teaching with the help of GeoGebra teaching is an effective method of stimulating learners to participate in the learning process. This method is suitable when used in conjunction with mathematical software, including GeoGebra. Discovery teaching with the help of GeoGebra software requires teachers to be brave. Teachers, through leading questions, have pedagogical intentions to help learners answer. From those answers, learners will construct knowledge software is a teaching method that requires time, effort, and money. However, the effectiveness of discovery teaching is much higher than that of traditional teaching methods. It is a student-centered teaching method. All the teaching process revolves around the student. Therefore, students are the most important subject of discovery teaching. Discovery teaching with the help of GeoGebra software helps students sustainably acquire knowledge. Discovery teaching focuses on the teaching process rather than testing and evaluating through grades.

### CONFLICT OF INTERESTS

The author has not declared any conflict of interests.

### REFERENCES

De Jong T (2006). Technological advances in inquiry learning. *Science* 312:532-533.  
 Ernst DC, Hodge A, Yoshinobu S (2017). What Is Inquiry-Based Learning? *Doceamus* 64(6):570-574.

Friesen S, Scott D (2013). Inquiry-Based Learning: A Review of the Research Literature (Paper prepared for the Alberta Ministry of Education).  
 GeoGebra (2021). GeoGebra.org. Retrieved from <https://www.geogebra.org/>  
 Gormally C, Brickman P, Hallar B, Armstrong N (2009). Effects of Inquiry-based Learning on Students' Science Literacy Skills and Confidence. *International Journal for the Scholarship of Teaching and Learning* 3(2, Article 16). <https://doi.org/10.20429/ijstol.2009.030216>  
 Harlen W (2013). Inquiry-based learning in science and mathematics. *Review of Science, Mathematics and ICT Education* 7(2):9-33.  
 Hmelo-Silver CE, Duncan RG, Chinn CA (2007). Scaffolding and achievement in problem-based and inquiry learning: A response to Kirschner, Sweller, and Clark (2006). *Educational Psychologist* 42(2):99-107.  
 Kirschner P, Sweller J, Clark R (2004). Why Unguided Learning Does Not Work: An Analysis of the Failure of Discovery Learning, Problem-Based Learning, Experiential Learning and Inquiry-Based Learning. *Educational Psychologist* 41(2).  
 Kogan M, Laursen SL (2014). Assessing Long-Term Effects of Inquiry-Based Learning: A Case Study from College Mathematics. *Innovative Higher Education* 39(3):183-199.  
 Laursen SL, Hassi ML, Hough S (2015). Implementation and outcomes of inquiry-based learning in mathematics content courses for pre-service teachers. *International Journal of Mathematical Education in Science and Technology* 47(2):256-275.  
 Laursen SL, Hassi ML, Kogan M, Weston TJ (2014). Benefits for women and men of inquiry-based learning in college mathematics: A multi-institution study. *Journal for Research in Mathematics Education* 45(4):406-418.  
 Le TT (2017). The application of Discovery learning in learning transformations. *Journal of Education of Vietnam* P 268.  
 Lê Thị Hồng Chi (2012). Vận dụng phương pháp khám phá trong dạy học môn Toán lớp 4:45-49.  
 Le VB (2007). Learning Ggeometry at The Last Classes at Under secondary School oriented discovery learning. Vinh university.  
 Madhuri GV, Kantamreddi VSSN, Prakash Goteti LNS (2012). Promoting higher order thinking skills using inquiry-based learning. *European Journal of Engineering Education* 37(2):117-123.  
 Nguyen NG (2016). Researching, designing and using e-textbooks in learning transformations on the plane according to the organization of dicoverable acts. The Vietnam National Institute of Educational Sciences.  
 Nguyen NG (2019). Integrating Mathematics, Informatics and Physics. The Hanoi National University Publishing House.  
 Nguyen TD (2014). Researching on The Lesson of Teacher focused on The Discovery of Mathematics of Students in Learning Mathematics at Upper Secondary School. Hanoi National University of Education.  
 Nguyen VH (2007). Applying the Discovery Learning with guiding in the Process of Teaching Mathematics at Upper Secondary School. *The Vietnam Education* P 158.

- Panasan M, Nuangchalem P (2010). Learning Outcomes of Project-Based and Inquiry-Based Learning Activities. *Journal of Social Sciences* 6(2):252-255.
- Phan TH (2013). Using the GeoGebra Software to Aid the Discovery Learning of Mathematical Theorem. *The Science Journal of Can Tho University* 27 p.
- Rooney C (2009). How am I using inquiry-based learning to improve my practice and to encourage higher order thinking among my students of mathematics? *Educational Journal of Living Theories* 5(2):99-127.
- Schoenfeld AH, Kilpatrick J (2013). A US perspective on the implementation of inquiry-based learning in mathematics. *ZDM - International Journal on Mathematics Education* 45(6):901-909.
- Spronken-Smith R Walker R (2010). Can inquiry-based learning strengthen the links between teaching and disciplinary research? *Studies in Higher Education* 35(6):723-740.
- Tran BH (2003). Learning with using Learners be Centered. *The Vietnam Information of Education Science* 96 p.
- Tran BH (2004). Learning by Discoverable Acts. *The Vietnam Information of Education Science* 102:2-6.
- Tran TTX (2011). The Discovery Learning of Genetic Dasis for Talent Students at Upper Secondary School. *Journal of Education of Vietnam*.
- Vu QK (2017). Helping pedagogical students to train problem solving competence through the exploitation of linear algebraic problems. *Journal of Education of Vietnam* 275:41-42.