

Full Length Research Paper

Inhibition effect of potassium dichromate on the corrosion protection of mild steel reinforcement in concrete

C. A. Loto^{1,2*}, O. A. Omotosho² and A. P. I. Popoola¹

¹Department of Chemical and Metallurgical Engineering, Tshwane University of Technology, Pretoria, South Africa.

²Department of Mechanical Engineering, Covenant University, P.M.B. 1023, Ota, Nigeria.

Accepted 11 April, 2011

The inhibition of potassium dichromate on the corrosion protection of mild steel embedded in concrete and partially immersed in sulphuric acid and sodium chloride environments was evaluated at ambient temperatures. The experiments were performed using electrochemical potential monitoring method. Varying quantities of the inhibitor was used. In the NaCl test medium, the effectiveness of the inhibitor improved as higher concentration was used. The best inhibition was achieved in the reinforced concrete sample admixed with 9 g potassium dichromate. Steel-reinforced concrete sample admixed with 3 and 9 g potassium dichromate inhibitor had the highest improvement in compressive strength. The potassium dichromate inhibitor was most effective amongst other inhibitor concentrations used when 7.5 g was admixed with the sample in the H₂SO₄ medium. The sulphuric acid medium had a deleterious effect on the strength of concrete test specimens.

Key words: Corrosion, passive/active corrosion, inhibitors, sulphuric acid, sodium chloride media.

INTRODUCTION

Steel reinforced concrete is a widely used construction material and its durability is based on the capability to withstand a range of severe environments over long service life. Corrosion is one of the major causes of steel degradation in concrete and has led to serious deterioration of concrete structures throughout the world. Virtually all industries are affected by this phenomenon as observed in the oil and process industry. It is known by Young et al. (2004) that steel in concrete is protected by a passive film that is formed as a result of, and maintained by the alkali pore solution in contact with the steel. The loss of alkalinity in concrete, however, is either chloride-induced or by carbonation. The environment around the steel in the concrete becomes corrosive in the presence of water and oxygen (Young et al., 2004). Corrosion occurrence on the surface of the reinforcing steel causes not only decrease of adhesion between the reinforcing steel and the concrete, but also the reduction

of the reinforcing steel section. The increase in the volume of the corrosion products in relation to the initial reinforcing steel initiates tensile stresses which cause appearance of fissures, cracking and setting apart (Franciskovic et al., 2006). This phenomenon makes it inevitable for researchers to find out more ways of reducing rebar corrosion rate. Corrosion in concrete can be prevented by several methods. Such methods include anodic protection, cathodic protection, rebar coating and the use of inhibitors. Amongst inhibitors widely employed to minimize corrosion of many metallic structures in various environments are nitrates, benzoates, phosphates, chromates and borates (Afolabi, 2008). Nitrate -based inhibitors, though older than chromate-based corrosion inhibitors have a long established reputation for effectively inhibiting corrosion of steel in concrete (Young et al., 2004). Inhibitors containing sodium and potassium ions have the tendency to maintain the pH between 12.5 and 13.5. Under this pH levels steel attains a high corrosion potential that leads to passivity.

Several authors have carried out series of experiments

*Corresponding author. E-mail: akinloto@gmail.com.

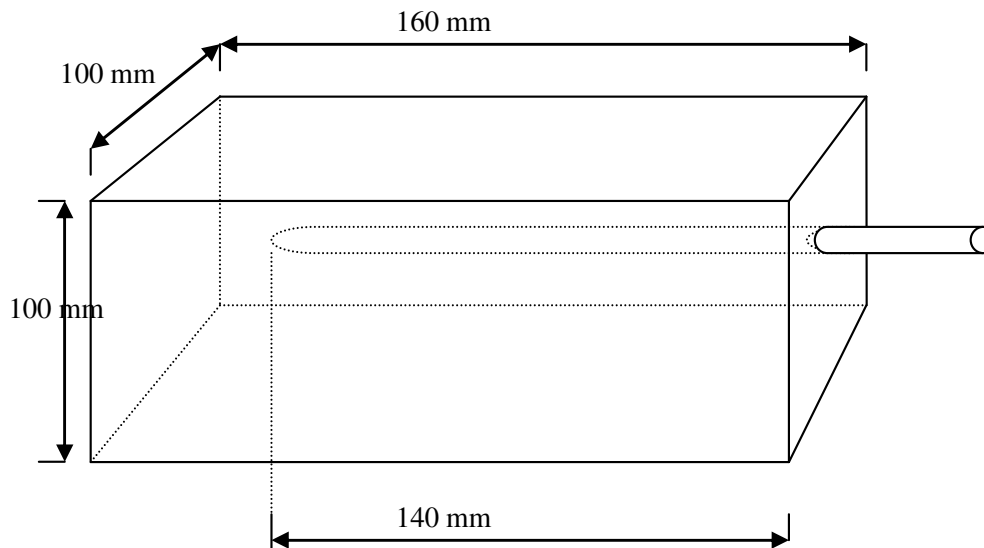

Figure 1. Schematic diagram of a steel-reinforced concrete block sample (drawing is not to scale).

on the use of inhibitors in concrete including Berke (1989), Griffin (1975), Loto and Odumbo (1989), Craig and Wood (1970) and Loto and Okusanya (1989); and they dwelt on nitrite, sulphides and benzoates. Their findings indicated dissimilar levels of corrosion activity. This work evaluates the inhibition performance of potassium dichromate inhibitor on mild steel reinforcement in concrete immersed in sulphuric acid and sodium chloride media. Sulphuric acid was used to simulate corrosion in bacterial or microbial environment. Sodium chloride was added to the concrete mix to accelerate the corrosion of the embedded steel by providing increased chloride ions in the matrix and particularly around the reinforcing steel rebar. The performance of this inhibitor in steel reinforced concrete particularly in the tropical areas is of utmost interest to researchers and relevant to industries.

EXPERIMENTAL PROCEDURE

Preparation of concrete samples

Concrete blocks made of Portland cement, sand, gravel and water each with a reinforcing steel rebar embedded in it were used for the experiment. Each concrete block was 160 mm long, 100 mm wide and 100 mm thick. All the blocks were prepared with 1:2:4 (CSG) – cement; sand; gravel ratio. The formulation used for the reinforced concrete specimens, in Kg/m^3 , was: cement-320; water-140; sand-700 and gravel-1150. The water/cement (W/C) ratio was 0.44 (Loto and Okusanya, 1989). Two groups of blocks were made. The first group consists of seven sets of blocks comprising several specimens, which were cast with different inhibitor concentration, admixed with fixed amount of sodium chloride. The percentages quoted for each of the admixed inhibitor and the sodium chloride was computed based on every 10 kg weight of the concrete from which the blocks were made. All the chemicals used were AnalaR grade. The sets were prepared is presented as follows:

1. Concrete admixed with 0.1 M NaCl solution without inhibitor.
2. Concrete admixed with 1.5 g $\text{K}_2\text{Cr}_2\text{O}_7$ and 0.1 M NaCl.
3. Concrete admixed with 3.0 g $\text{K}_2\text{Cr}_2\text{O}_7$ and 0.1 M NaCl.
4. Concrete admixed with 4.5 g $\text{K}_2\text{Cr}_2\text{O}_7$ and 0.1 M NaCl.
5. Concrete admixed with 6.0 g $\text{K}_2\text{Cr}_2\text{O}_7$ and 0.1 M NaCl.
6. Concrete admixed with 7.5 g $\text{K}_2\text{Cr}_2\text{O}_7$ and 0.1 M NaCl.
7. Concrete admixed with 9.0 g $\text{K}_2\text{Cr}_2\text{O}_7$ and 0.1 M NaCl.

Set 1 aforementioned was the control sample. The steel rebar used for the reinforcement has the chemical composition of: 0.3% C, 0.25% Si, 1.5% Mn, 0.04% P, 0.64% S, 0.25% Cu, 0.1% Cr, 0.11% Ni, and the rest Fe. The rebar was cut into several pieces each with a length of 160 and 10 mm diameter. An abrasive grinder was used to remove any mill scale and rust stains on the steel specimens before it was embedded in each concrete block. The remaining 20 mm protruded at one end of the block, and was painted to prevent atmospheric corrosion (Figure 1). This part was also used for electrical connection. The test media used for the investigation were: 3.5% NaCl solution and 0.5 M dilute sulphuric acid. The second group consists of two concrete blocks without any admixed inhibitor. They were made purposely for determining strength under different curing conditions. One of the concrete blocks in the second group was cured in air for two weeks, and the other was cured in water for the same period.

Potential measurement

Each concrete block was partially immersed in their respective test media of sulphuric acid and sodium chloride such that the liquid level was just below the exposed part of the reinforcing steel to avoid direct contact. The potential readings were obtained by placing a copper sulphate electrode firmly on the concrete block as shown in Figure 2. One of the two lead terminals of a digital multimeter was connected to the copper sulphate electrode and the other to the exposed part of the embedded steel rebar to make a complete electrical circuit. The readings were taken at three different points on each concrete block directly over the embedded steel rebar (Griffin, 1975; Loto and Okusanya, 1989). The average of the three readings was computed as the potential reading for the

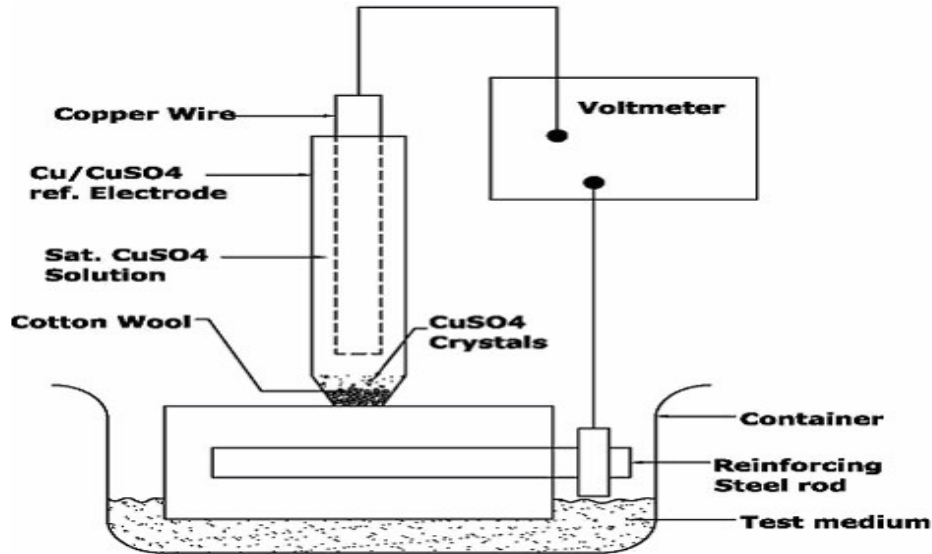

Figure 2. Schematic diagram of experimental set up.

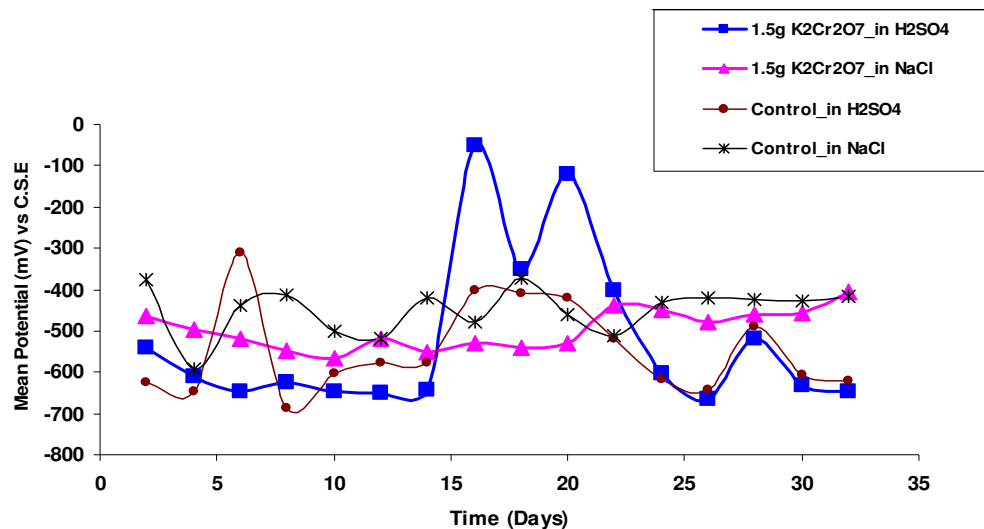

Figure 3. Curves of mean potential vs time for the concrete test sample admixed with 1.5g K₂Cr₂O₇ and 0.1 M NaCl in sulphuric acid and sodium chloride media.

embedded rebar in 2-day intervals for a period of 32 days. All the experiments were performed under free corrosion potential and at ambient temperature.

Determination of the compressive strength of the test specimens

The effect of admixed inhibitor on the compressive strength of the concrete test samples was determined using the concrete samples in the second group of specimens mentioned earlier. After the potential monitoring period, the original steel-reinforced concrete test samples were removed from their respective test media and allowed to air harden for seven days. Then, each of the concrete

blocks was weighed, placed on a compressive fracture machine lengthwise and loaded until the concrete block gently disintegrated.

RESULTS AND DISCUSSION

Test samples in sulphuric acid medium

The curves of mean potential versus time for the control sample and sample admixed with 1.5 g K₂Cr₂O₇ and 0.1 M NaCl are presented in Figure 3. Potential reading in the control sample moved from the active region at -620 mV

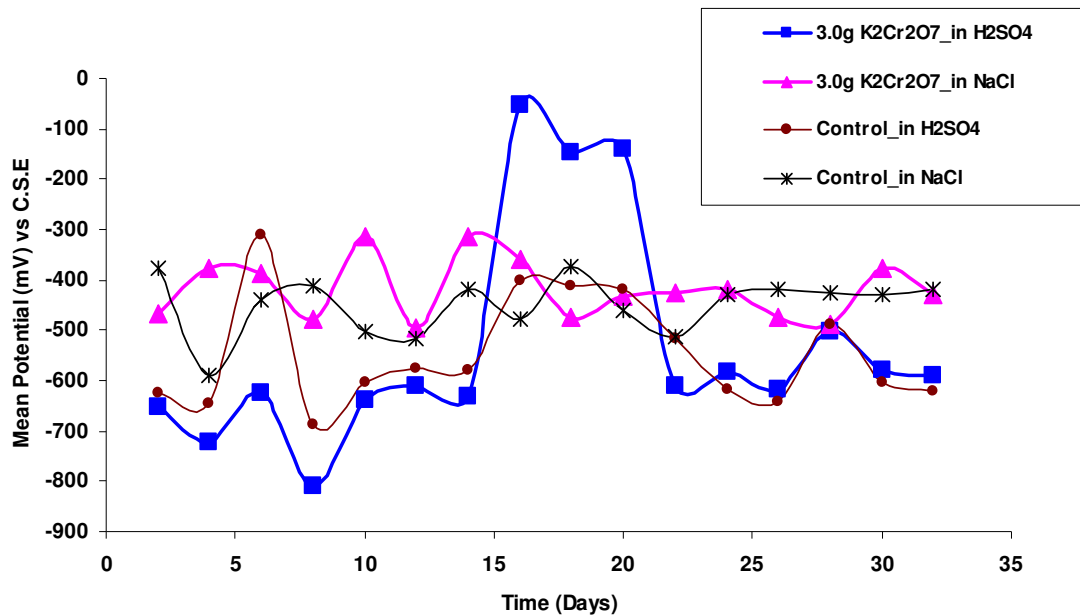

Figure 4. Curves of mean potential vs time for the concrete test sample admixed with 3 g $K_2Cr_2O_7$ and 0.1 M NaCl in sulphuric acid and sodium chloride media.

(CSE) to the passive region at -300 mV (CSE) on the 6th day. This could be due to the sulphate ions in the medium that had not reached the steel surface. The initial diffusion and corrosion reactions by these reacting species could be hindered by the alkaline pore solution of the concrete. From the 8 to the 14th day, steel potential was in the active region, before drifting towards the passive region until the 20th day. The active potential observed could be due to the action of sulphate ions that might have destroyed the protective alkaline film barrier on the embedded steel surface. The subsequent corrosion products stifled the corrosion reaction and this resulted in the passive potential. Steel potential after the 20th day, however, became active till the end of the experiment. This again, could be as a result of the dissolution of the corrosion products which exposed the steel surface. Steel rebar concrete sample admixed with 1.5g $K_2Cr_2O_7$ in the H_2SO_4 medium showed initial active corrosion averaging -642 mV (CSE) in the first 14 days of the experiment. This was followed by a drift towards passive corrosion state from the 16 to the 24th day. The inhibitor at the amount used might have succeeded in gradually building a passive film on the steel rebar during the period of passive potential readings. The aggressive nature of the H_2SO_4 medium resulted in active potential readings as the steel rebar showed active corrosion condition after 24th day till end of the experiment. The concentration of the inhibitor used was insufficient to reduce corrosion effectively in the H_2SO_4 medium. For the first eight days of the exposure period, it was observed that the steel reinforced concrete sample admixed with 3 g $K_2Cr_2O_7$ in the H_2SO_4 medium showed active corrosion

condition with a potential reading of less than -800 mV(CSE) as shown in Figure 4. This was probably due to the deterioration induced as a result of the activities of sulphate ions in the acidic medium.

The potential of the steel rebar gradually shifted towards the passive region until it reached a value greater than -100 mV (CSE) on the 16th day. This relatively passive reading was maintained until the 20th day of the experiment. This condition could be attributed to the higher inhibitor content in the test sample when compared to the previous sample. The breakdown of passive film, therefore resulted in active corrosion condition of about -700 mV (CSE) at the end of the experiment. The sample admixed with 4.5 g $K_2Cr_2O_7$ and partially immersed in H_2SO_4 medium is shown in Figure 5. The potential reading was in the active region for the first 14 days of the experiment indicating that the inhibitor was not effective when compared with the control sample during the same time frame. The potential drifted into the passive region with a mean value of -100 mV (CSE) from the 16 to the 20th day, as the inhibitor became effective. After the 20th day till the end of the experiment, the inhibition effectiveness of potassium dichromate decreased due to the aggressive acid medium that destroyed the barrier created by the inhibitor. The potential reading of the steel rebar concrete sample admixed with 6 g $K_2Cr_2O_7$ and partially immersed in H_2SO_4 medium in Figure 6 showed the same behavior of initial active corrosion from the beginning to the 14th day of the experiment like the previous sample. Steel rebar potential then moved into the passives region from the 16 to the 26th day of the experiment and remained there for

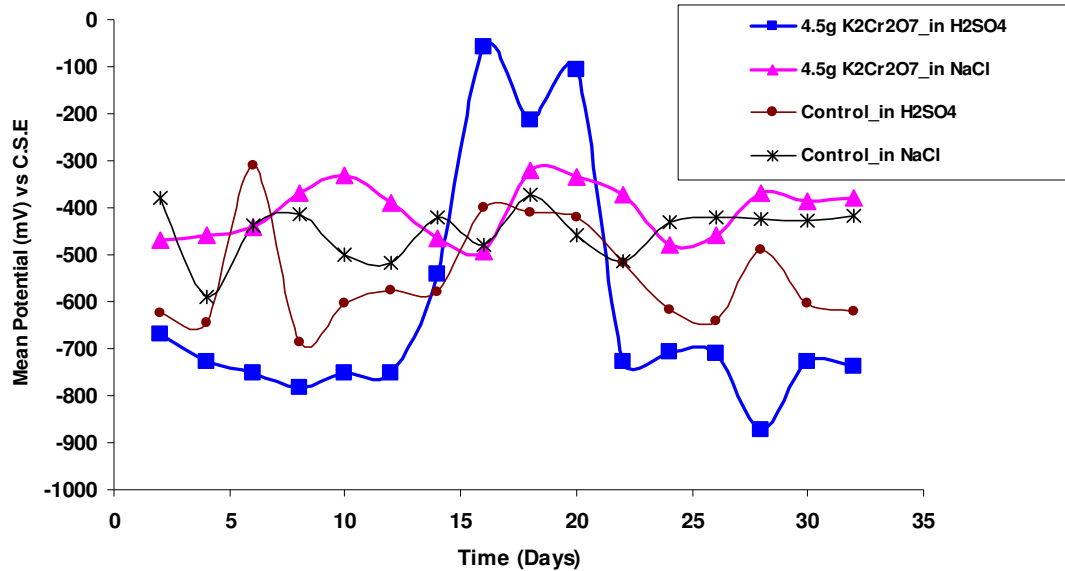

Figure 5. Curves of mean potential vs time for the concrete test sample admixed with 4.5 g $K_2Cr_2O_7$ and 0.1 M NaCl in sulphuric acid and sodium chloride media.

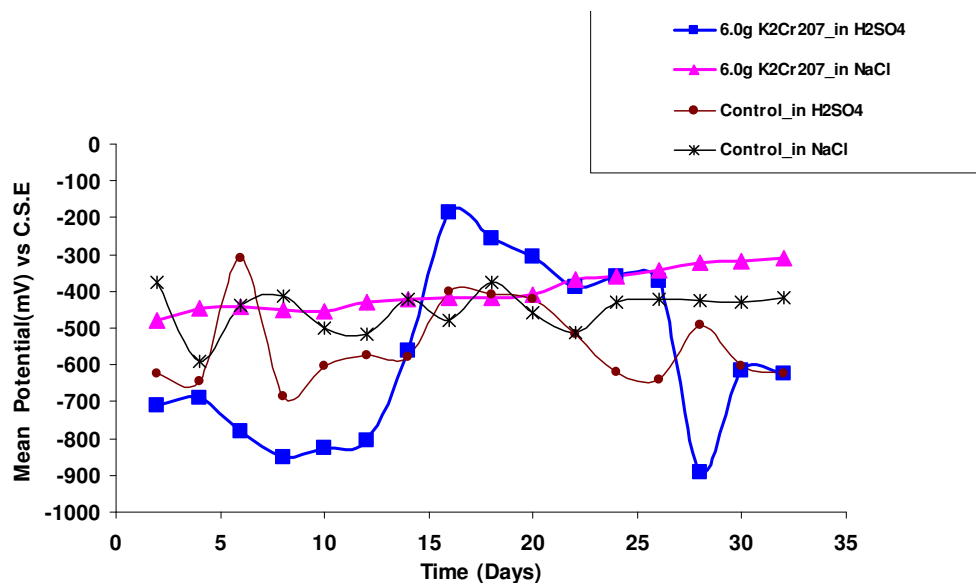

Figure 6. Curves of mean potential vs time for the concrete test sample admixed with 6 g $K_2Cr_2O_7$ and 0.1 M NaCl in sulphuric acid and sodium chloride media.

a longer period probably due to the higher concentration of the inhibitor. After the 26th day, the acid medium seemed to have destroyed the passive film created by the inhibitor, which made the steel rebar potential to become active till the end of the experiment. Initial potential reading of steel rebar concrete sample admixed with 7.5 g $K_2Cr_2O_7$ and partially immersed H_2SO_4 medium as shown in Figure 7 was in the active region but not as low as what was observed in the previous sample. This is

perhaps an indication of initial effectiveness of the inhibitor at the concentration used. The potential reading attained a value of -100 mV (CSE) on the 16th day however, the shift downwards, from the 18th day to the end of the experiment into the active corrosion region, was probably due to the breakdown of the passive film.

Corrosion potential records from the 6 to the 24th day of the experiment, as shown in Figure 8 are marked by persistent and frequent spikes varying in amplitude from

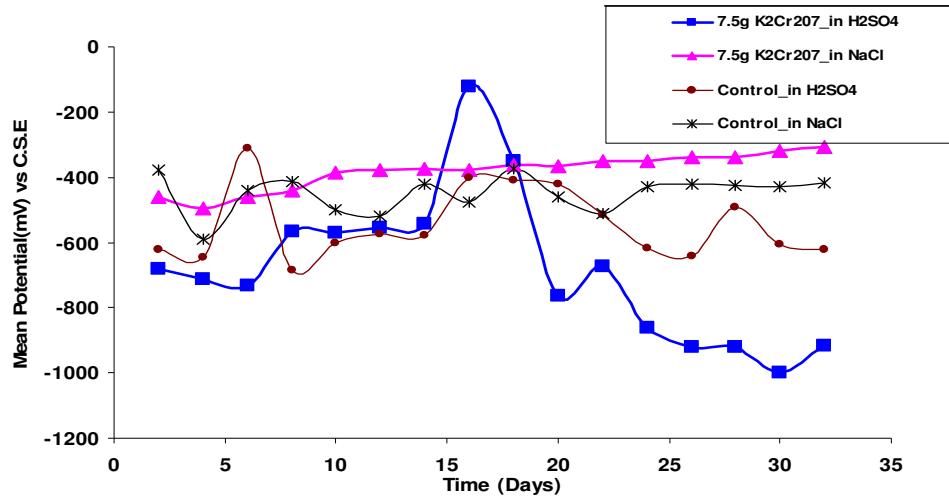

Figure 7. Curves of mean potential vs time for the concrete test sample admixed with 7.5 g $K_2Cr_2O_7$ and 0.1 M NaCl in sulphuric acid and sodium chloride media.

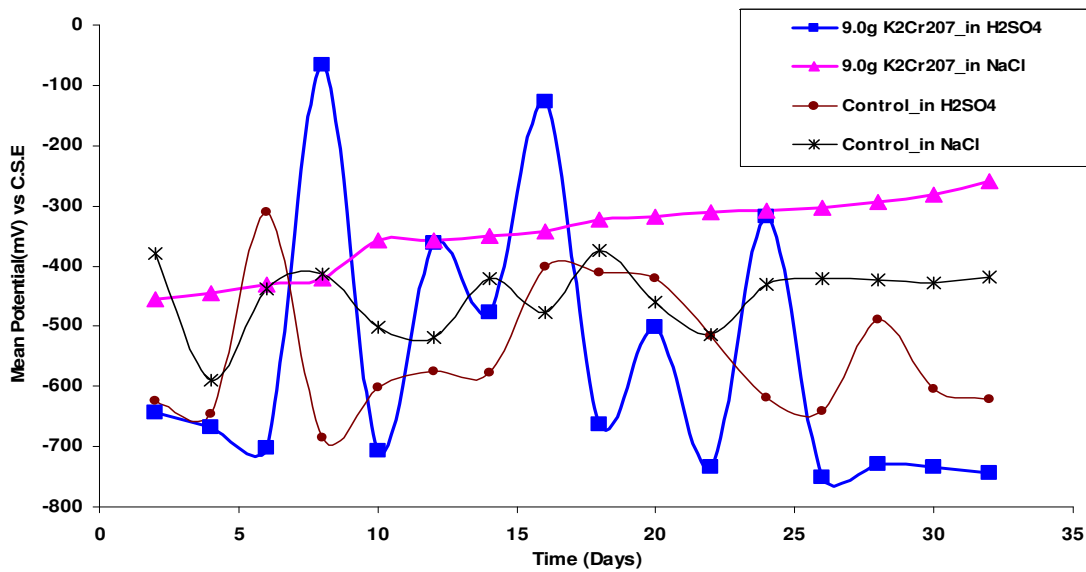

Figure 8. Curves of mean potential vs time for the concrete test sample admixed with 9 g $K_2Cr_2O_7$ and 0.1 M NaCl in sulphuric acid and sodium chloride media.

a unit of 1 to more than 100 mV. These spikes could be explained to be due to the persistent contest between passivation in the highly alkaline pH of hydrated cement and corrosion in the acidic pH of active anodes caused by sulphate ions. However, steel potential readings remained in the active region till the end of the experiment, and this could be due to the aggressive nature of the acidic medium.

Test samples in sodium chloride media

The potential reading of the control test samples in the

NaCl medium in Figure 3 shifted from the passive region of -350 mV (CSE) to the active region of -600 mV (CSE) in the first 4 days of the experiment. After the 4th day, potential readings increased gradually to -400 mV (CSE) on the 16th day showing that the alkaline barrier between steel rebar and the chloride ions in the matrix was still able to prevent corrosion. This potential reading was maintained till the end of the experiment except for the fluctuation on the 24th day. The curve for the steel concrete sample admixed with 1.5 g $K_2Cr_2O_7$ and partially immersed in the NaCl medium is shown in Figure 3. Though the potential was drifting towards the active region, in the first 10 days, it was observed that the chloride

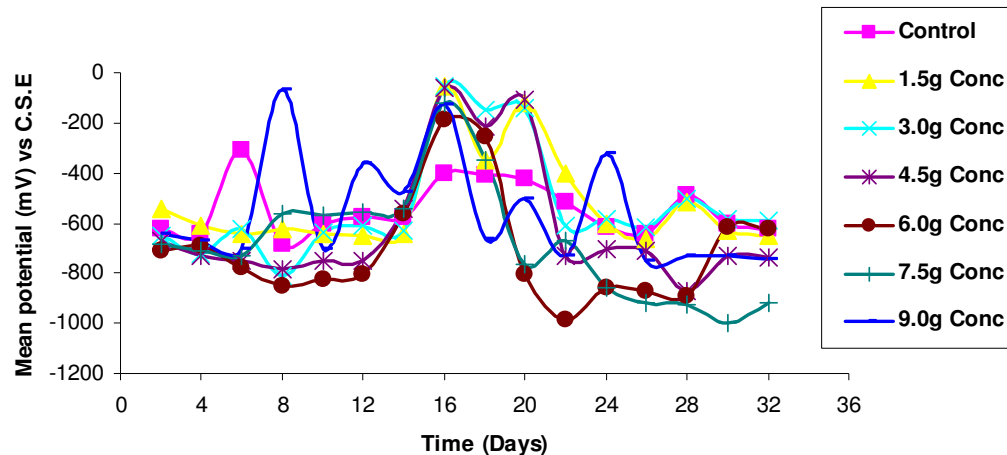

Figure 9. Variation of corrosion potential with time for mild steel reinforcement in concrete admixed with varying amount of potassium dichromate in H_2SO_4 medium.

ions initiating this action were not strong enough to allow a sharp shift into the very active corrosion region. Perhaps the inhibitor also forestalled this downward drift at the concentration used, since the trend of the potential readings was gradually in the upward direction from the 14th day to the end of the experiment. The curve of the mean potential versus time for steel rebar sample admixed with 3 g $K_2Cr_2O_7$ partially immersed in NaCl medium is shown Figure 4. The recorded potential reading showed a fluctuation between -350 and -580mV (CSE) throughout the experimental period. This indicated that the inhibitor was not effective enough at the concentration used. However, the readings were better when compared with the control experiment in NaCl medium. In the first 10 days of the experiment, steel rebar concrete sample admixed with 4.5 g and partially immersed in NaCl medium, Figure 5, showed initial shift towards the passive region.

The potential reading of -320 mV (CSE) achieved on the 10th day could be as a result of the inhibiting action of the inhibitor at the concentration used. Apart from the 18 and 24th day of the experiment, where the readings were in the active corrosion region, potential values for the remaining experimental days were in the passive region. This indicated an increase in the effectiveness of the inhibitor at this concentration when compared with the former (3 g). The mean potential versus time curve of concrete test sample admixed with 6 g $K_2Cr_2O_7$ and partially immersed in sodium chloride media is shown in Figure 6. The steel rebar potential showed a trend in the upward direction from -500 mV (CSE) in the beginning to -300 mV (CSE) at the end of the experiment. This could be as a result of the increase in the concentration of the inhibitor which was able to suppress the action of the chloride ions throughout the experimental period. The potential of the concrete test sample admixed with 7.5 g $K_2Cr_2O_7$ and partially immersed in sodium chloride media

showed initial shift towards the passive region in Figure 7. This upward trend was exhibited throughout the experimental period. This could be explained to be due to further increase in inhibitor concentration. In addition, it was probable that the chloride ions in the matrix and medium could not effectively destroy the film barrier created by the inhibitor throughout the experimental period. Figure 8 shows the curves obtained for the concrete sample premixed with 9 g $K_2Cr_2O_7$ and partially immersed in NaCl medium.

The record of the potential readings showed that the steel rebar potential was in relatively passive region throughout the experiment. The potential reading was -450 mV (CSE) at the beginning and it gradually increased to -280 mV (CSE) at the end of the experiment. Fluctuation spikes were not recorded throughout the experimental period. This is a clear indication of the effectiveness of the inhibitor throughout the experimental period.

Comparative performance of increasing the inhibitor concentration in sulphuric acid and sodium chloride media

Potential versus time curves for steel rebar embedded in concrete premixed with varying concentrations of the inhibitor and partially immersed in H_2SO_4 and NaCl media respectively are presented in Figures 9 and 10. The curves show the overall picture of the effectiveness of increasing the amounts of inhibitor used. Comparing the curves for the different media it is obvious that the potassium dichromate inhibitor was more effective in the NaCl media. A reduction in the negative potential of steel was demonstrated by the NaCl media throughout the experimental period. It is also observed that higher amount of the inhibitor produced better inhibition for both

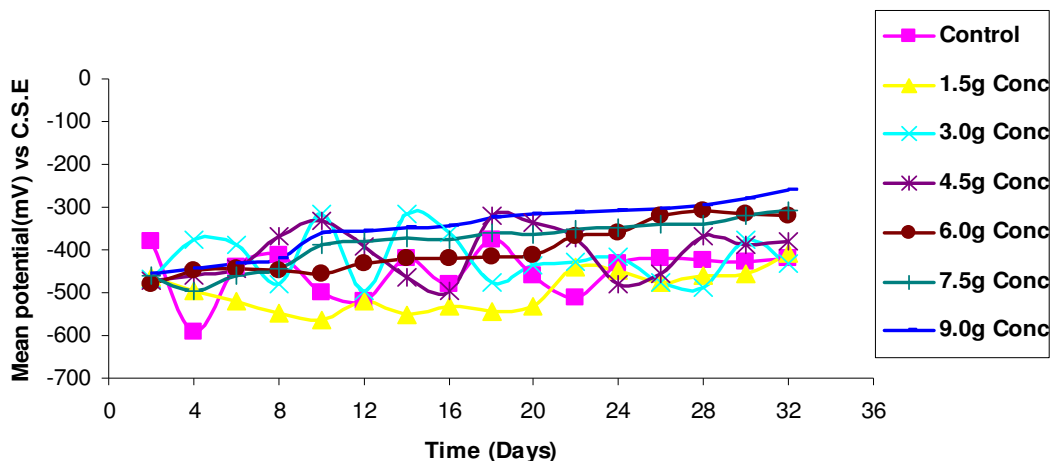

Figure 10. Variation of corrosion potential with time for mild steel reinforcement in concrete admixed with varying amount of potassium dichromate in NaCl medium.

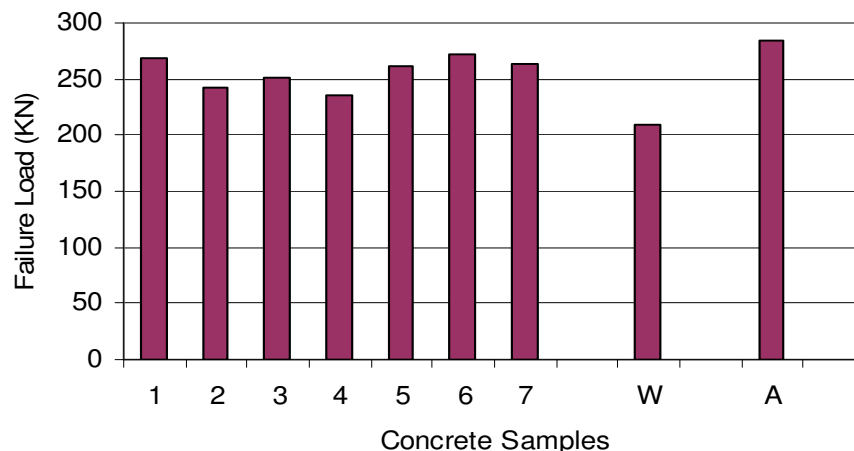

Figure 11. Histogram of the compressive fracture load for the reinforced concrete specimens immersed in sulphuric acid. W=concrete specimen cured in water, A = concrete specimen cured in air. Numbers 1 to 7 represents the list of concrete specimen described previously in the experimental procedure.

media but it could not be sustained in the H_2SO_4 medium. The passivation (formation of surface films) and depassivation phenomena fluctuated throughout the experimental period in the sulphuric acid medium. Furthermore, it can be observed that the inhibitor did not totally stop corrosion but only reduced or delayed its onset in this corrosive environment. The inhibition effectiveness in the NaCl medium (Figure 10) at higher concentration, must have been due to the chloride ions (Cl^-) inability to penetrate and break down the inhibitor created passive film on the embedded steel surface. The potential readings ranged between -250 and -550 mV (CSE), throughout the experimental period.

The best performance was obtained when 9 g of potassium dichromate was admixed with the concrete

sample. Corrosion potential readings were in the passive region throughout the experimental period with values ranging from -450 to -250 mV (CSE). The sulphate ions in the H_2SO_4 medium did not permit the effective inhibition of potassium dichromate. Most of the potential readings were in the active corrosion range of -400 to -20 mV (CSE).

Compressive strengths of concrete test sample

The analysis of compressive fracture load data for steel-reinforced concrete samples partially immersed in NaCl and H_2SO_4 medium are presented in Figures 11 and 12 respectively. The strengths of all reinforced concrete

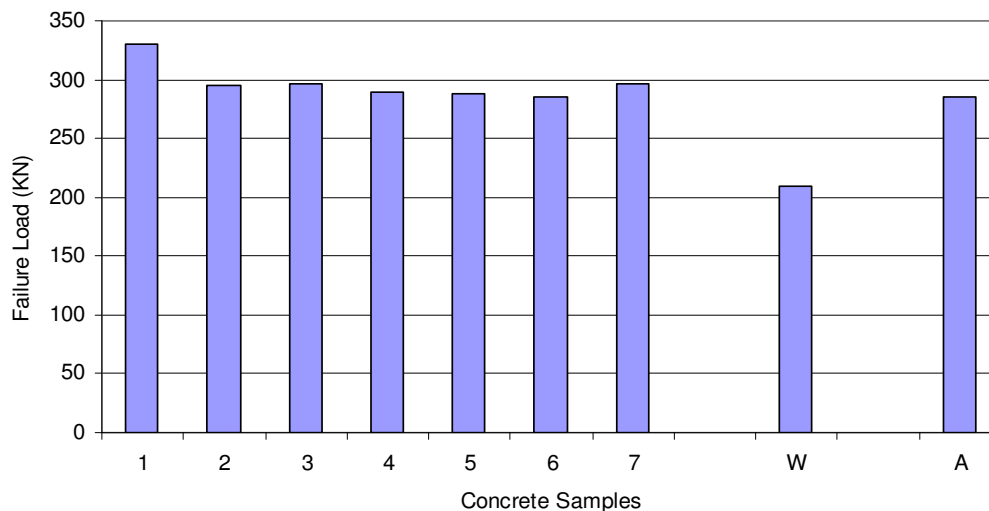

Figure 12. Histogram of the compressive fracture load for the reinforced concrete specimens immersed in NaCl medium. W = concrete specimen cured in water, A= concrete specimen cured in air. Numbers 1 to 7 represents the list of concrete specimen described previously in the experimental procedure.

specimens used in the experiments and partially immersed in H_2SO_4 and NaCl media were higher than those of the specimen cured in water for two weeks. This indicates that the admixed inhibitor had no adverse effect on the concrete samples used. The reason for the higher compressive strength in the admixed samples than in the sample cured in water is difficult to explain. It could probably be due to the relative chemical reactions hardening effect of the inhibitor with the concrete. In addition the specimens used for the monitoring experiments were partially immersed in H_2SO_4 and NaCl media. The other halves were exposed to the air throughout the experimental period. The values of the compressive strengths, obtained for the test samples partially immersed in H_2SO_4 and NaCl media did not follow a particular trend when compared with the compressive strength values of the concrete specimens cured in air. All the specimens used in the H_2SO_4 medium gave a loss in compressive strength when compared with specimens cured in air. However, specimens used in the NaCl medium gave increases in the compressive strengths when compared to the specimens cured in air. It is apparent from the result that addition of potassium dichromate reduces the compressive strength of concrete samples in H_2SO_4 medium while it increases the compressive strength of the concrete samples in the NaCl medium. The control sample without inhibitor in the NaCl medium showed an increase in compressive strength while it displayed reduced strength in the H_2SO_4 medium. This shows that sulphuric acid had a deleterious effect on the strength of concrete.

The results in Figure 11 show that the addition of 7.5 g of potassium dichromate produced the highest improvement in compressive strength for samples

partially immersed in H_2SO_4 medium.

Conclusion

1. Increasing the concentration of the inhibitor proved more effective in the NaCl medium than the sulphuric acid medium.
2. The potassium dichromate inhibitor proved most effective amongst other inhibitor concentration when 7.5 g was admixed with the sample in the H_2SO_4 medium.
3. Concrete samples with 3 and 9 g potassium dichromate admixture showed the highest improvement in compressive strength in the NaCl media. Both produced compressive strength of 296 KN.
4. The concrete sample with the best compressive strength was the control sample (containing 0.1 M NaCl) in the NaCl medium.
5. The overall best inhibition was achieved in the reinforced concrete sample admixed with 9 g potassium dichromate in NaCl medium.

REFERENCES

- Afolabi AS (2008). Synergistic inhibition of Potassium Chromate and Sodium Nitrite on Mild Steel in Chloride Sulphide media. [http://lejpt.academicdirect.org/A1/143_154.htm accessed 7/18/2008].
- Berke NS (1989). The Use of Calcium Nitrite as a Corrosion Cathodic Protection for Highway Bridges, Mater. Perform., 28(10): 41.
- Craig R, Wood LE (1970). Effectiveness of corrosion inhibitors their influence on the physical properties of Portland cement mortars.
- Franciskovic J, Boris M, Ivan R, Mijo T (2006). "Protection and repair of reinforced concrete structures by means of mci-inhibitors and corrosion protective materials." Proceedings on Structural Engineering Conferences: International Conferences on Bridges, [http://www.cortecvci.com/Publications/Papers/057%20Protection%2.

0and%20repair%20of%20reinforced%20concrete.pdf accessed
3/26/2010] 554
Griffin DF (1975). Corrosion of metals in concrete. Detroit M: American
Concrete Institute, 65.
Loto CA, Odumbo ET (1989). Electrochemical potential monitoring of
corrosion and coating protection of mild steel reinforcement in
concrete. Corrosion, 45(7): 535.

Loto CA, Okusanya A (1989). The influence of clay addition on the
electrochemical corrosion behavior of mild steel in concrete.
Corrosion Prev. Control J., 36(4): 105.
Young X, Hailong S, Miksic BA (2004). Comparison of inhibitors. MCI
and NaNO₂ in carbonation-induced corrosion. Mater. Perform., 1: 42-
46.