

*Full Length Research Paper*

# Optical observation of streamer propagation and breakdown in seed based insulating oil under impulse voltages

Mohammed I. Qureshi<sup>1</sup>, Abderrahmane Beroual<sup>2</sup> and Essam A. Al-Ammar<sup>3</sup>

<sup>1</sup>Research Center, College of Engineering, King Saud University, Riyadh, Saudi Arabia.

<sup>2</sup>Ecole Centrale de Lyon, University of Lyon, Ecully, France.

<sup>3</sup>Saudi Aramco Chair in Electrical Power, Dept of Electrical Engineering, King Saud University, Riyadh, Saudi Arabia.

Received 16 March, 2014; Accepted 10 July, 2014

**Increasing demand of electricity and high consumption of natural fuel resources has raised countless challenges for the electricity industry. For years, transformers were equipped with mineral oil for better and lasting performance but the recent uncertainty about the future of oil availability is motivating the researchers to find out the “Green Insulating Oils” for transformers. Thus, green insulating oils are being probed with great interest at research centers worldwide. In this paper, Canola oil was studied for applications in transformers as a sustainable solution. It presents experimental results of a comparative study of initiation and propagation of streamers in canola seed based oil and mineral insulating oil when subjected under standard lightning impulse voltages. Moreover, streamer patterns, modes of propagation and their stopping lengths were investigated under both polarities of voltage in point-plane electrode gap. The paper concludes with six different findings, which states that canola oil is a better and sustainable choice of oil for transformer use.**

**Key words:** Breakdown, impulse voltage, oil, seed based insulating oil, streamer propagation.

## INTRODUCTION

Mineral oil based dielectric fluids are applied in a large variety of electrical power equipment. Worldwide estimates show that almost 30 to 40 million tons of mineral insulating oils are in use. The functions of these oils are to fill the air cavities of the porous solid insulation in order to improve its partial discharge behavior as well as to act as a heat transfer medium to

dissipate the losses (Oommen, 2002). However, mineral oils are easily flammable, are poorly degradable and can contaminate soil and water, if spillover takes place. In addition, the increasing crisis of petroleum oil that is currently leading to uncertainty in its sustainable supply has forced the researchers worldwide to find suitable alternate sources (Claiborne et al., 1999; Amanullah et

E-mail: [essam@ksu.edu.sa](mailto:essam@ksu.edu.sa)

Author(s) agree that this article remain permanently open access under the terms of the [Creative Commons Attribution License 4.0 International License](http://creativecommons.org/licenses/by/4.0/)

**Table 1.** Measured properties of the investigated fluids.

Property		Unit	Canola Oil	Mineral Oil
Density at 23°C		kg/dm <sup>3</sup>	0.98	0.89
Viscosity at:	30°C	mm <sup>2</sup> /s	28	23
	60°C		12	6.5
Acidity		mgKOH/g	0.1315	0.056
Water Content		ppm	125	15
(60 Hz) AC Breakdown Voltage using IEC Mushroom Electrodes with 1.0 mm separation		kVrms	43	34
Dielectric Dissipation Factor (tan δ) at	23°C		0.0027	0.0011
	80°C		0.019	0.01
Permittivity (ε <sub>r</sub> ) at	23°C		3.07	2.2
	80°C		2.85	2.05

al., 2005; Perrier et al., 2004).

In this context, the vegetable seed oils are natural products and have renewable sources with plenty of supply and present suitable “green products” that can replace the mineral based oils. Their most attractive features are the high biodegradability (95 to 100%) and higher fire point (~360°C) instead of ~160°C for most mineral based insulating oils. Researches on pre-breakdown and breakdown phenomena of mineral based insulating liquids have been progressing since 1950s (Sharbaugh et al., 1978; Beroual et al., 1998) respectively. Martin and Wang (2008); Rapp et al. (2009) and Yasuda et al. (2010) exemplify the use of vegetable oils for dielectric applications in power distribution transformers and other high voltage equipments. Nevertheless, recently transformer-grade vegetable oils are also commercially available. The first commercial product was BIOTEMP, patented in the U.S. in September 1999 by ABB. Another U.S. patent was also issued in September 1999 for transformer oil which uses regular soybean oil. Moreover, another U.S. patent was granted to Cooper Industries, Inc. under the trademark of Envirottemp FR3 (Moumine et al., 1995).

This fluid is based on standard-grade oleic oils, and is used commercially in some distribution transformers. Subsequent patents were also issued to the ABB inventors on the BIOTEMP fluid in August 2001 (Oommen and Claiborne, 1999; McShane et al., 2000).

In Badent et al. (2000) two types of oils that is, Vegetable Canola oil (VO) and Transformer grade mineral oil (MO) are investigated. Canola oil is kitchen grade pure oil and its main molecular composition is triglycerides and fatty acid containing both saturated as well unsaturated fatty components with up to 23 carbon chain lengths containing double bonds. Due to the presence of double bonds, it is prone to oxidation under thermal stress when in contact with copper or other metals. To overcome these problems, antioxidants such as

Butylated Hydroxyanisole (BHA) and Butylated Hydroxytoluene are mixed in the bulk oil. Moreover, further reason to select the Canola oil is that several ester groups and other radicals are also present in Canola oil. The viscosity neutralization number and dissipation factor in Canola oil are higher than in mineral oil but these are within the accepted limits specified in international standards for mineral insulating oils. The higher values of permittivity at  $\epsilon_r = 3.07$  and hydrophilic character of Canola oil is expected to provide better edge to designers as compared to mineral oil, provided it is chemically synthesized and refined by stripping it off the radicals that make it prone toward oxidation and the ones that control its viscosity.

On the other hand, mineral oil molecules mainly consist of carbon and hydrogen atoms arranged in different structures such as paraffinic, naphthenic and aromatics. Their composition varies depending on the source, and the aromatic content plays a major role in the formulation of the streamer shapes (Badent et al., 2000; Devins et al., 1981). Some salient properties of these oils were measured in the laboratory and are summarized in Table 1.

## EXPERIMENTAL SETUP

The experiment set up for detection of initiation and propagation of streamers in the investigated liquids is shown in Figure 1. A test cell comprising of point-plane electrode system was designed and used. Its main body was made of PTFE material and its top lid was of transparent PMMA (“Perspex”) to facilitate the observation of inter electrode gap events. Tungsten and high carbon steel needles with tip radius of 10 μm were used. The plane electrode was made of brass having a diameter of 50 mm with its edges rounded.

A Perspex sheet barrier of 3 mm thickness was embedded on its surface to protect the electrode and the attached detection equipment at the advent of oil breakdowns. The electrode gap was arranged in horizontal format and is shown in Figure 2. Haefely 10-

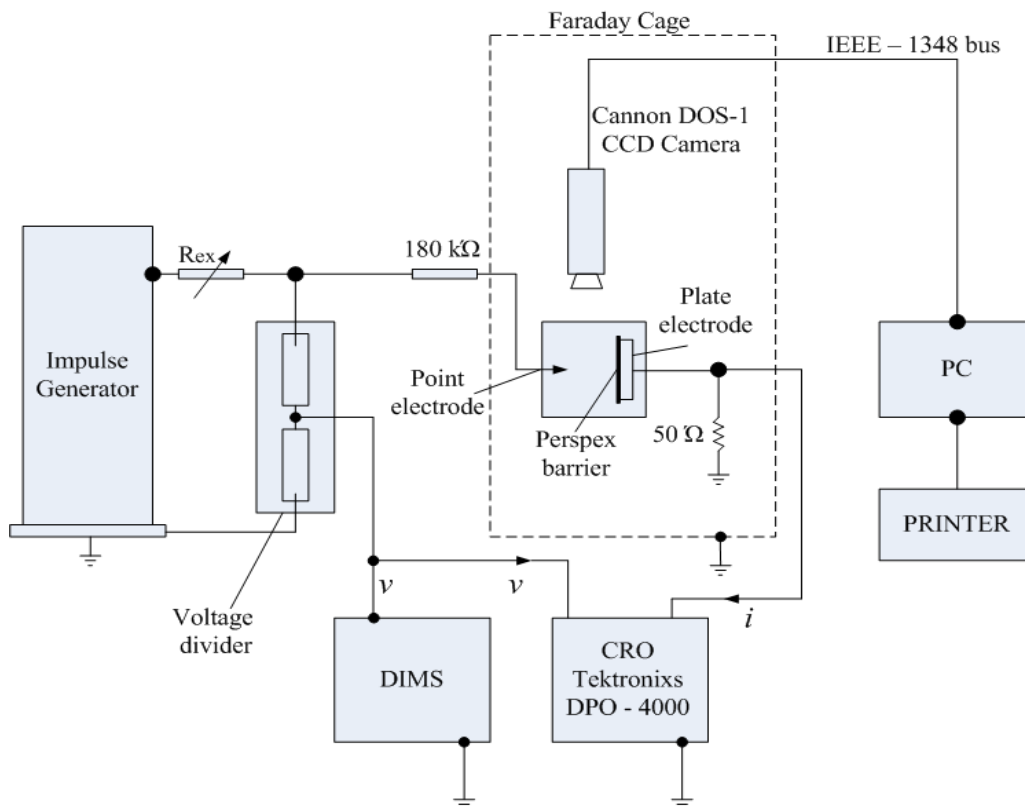

Figure 1. Sketch of experimental set up.

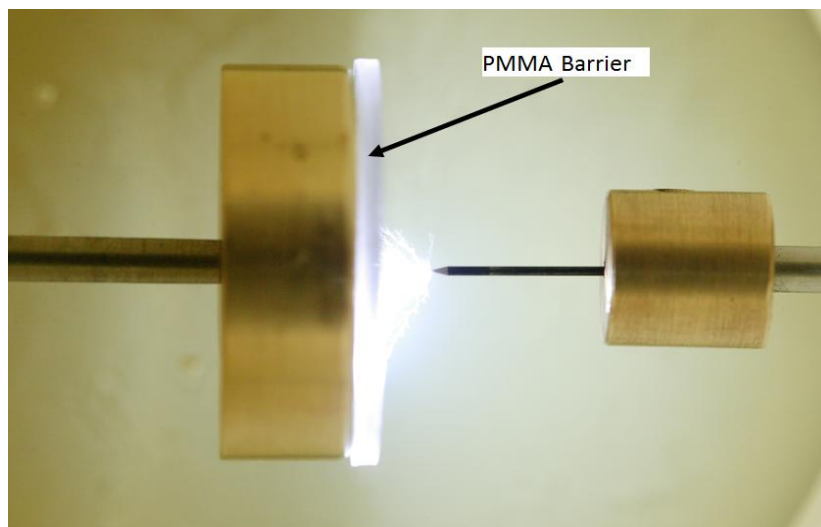
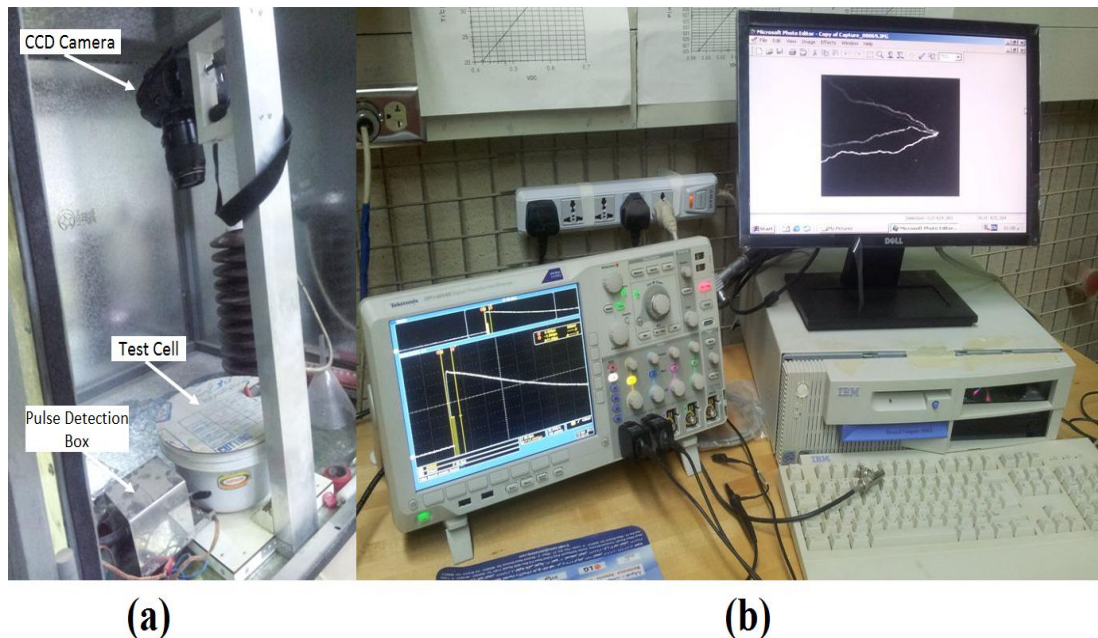

Figure 2. Electrode gap in the test cell.

stage impulse generator with 100 kV, 4 kJ output per stage was used to produce standard lightning impulse voltages which were measured through an RC voltage divider and Digital Impulse Measuring System (DIMS). The voltage signal and current signal

coming from the precision non-inductive 50 Ω resistor were fed to a 400 MHz oscilloscope for data acquisition. A 180 kΩ resistor was connected at the output of the impulse generator to limit the breakdown current and injected energy into the test cell.



**Figure 3.** Experimental arrangement: (a) CCD camera, test cell and pulse detection box, (b) PC and oscilloscope connected with the incoming signal cables.

The shadowgraph system consisting of a 15 Mega pixel CCD Camera, which could be used with or without a flash was employed. Instead of conventional shadow graphic system in which the streamer channels are displayed in the background of a trigger light pulse, the self-irradiated light from filaments of streamers was used to capture the events. The camera was opened for 5 s synchronously with the operation of the trigger pulse applied to the impulse generator. This exposure time and any delay in the operation of trigger system were found optimum to capture the events associated with the applied voltage impulse. Moreover, Figure 3 displays photographically the set up with camera, test cell and other detection instruments connected together.

## RESULTS AND DISCUSSION

Streamer characteristics of the two types of oils mentioned earlier were investigated. Comparisons were made for the shapes using propagation modes including their stopping lengths. This study was mostly carried out using a middle size electrode gap of 20 mm (from industrial application's point of view), with a point electrode tip of 10  $\mu\text{m}$  radius. The streamer shapes in mineral oils had the same behavior as had already been reported in (Dang et al., 2012) and therefore these were not documented here to avoid duplication. Therefore, results presented here are for the streamers in Canola oil that were captured using both polarities of standard lightning impulse voltages (1.2/50  $\mu\text{s}$ ). However, the analysis and discussion are made for both types of the oils investigated that is mineral oil and canola oil.

## Electrical characteristics of selected oils

The most important properties of insulating oils are the dielectric ones beside the usual physico-chemical characteristics. Vegetable oils possess high flash and fire point as compared to mineral based oil. This typical character lends strong support to adopt these oils in transformers located in hazardous locations. The combination of fire safety and high biodegradability (> 98%) can eliminate the traditional need for fire walls and deluge systems built around transformer banks (McShane et al., 1999; CIGRE WG A2-35 Brochure, 2010).

The A.C breakdown strength of vegetable oils was not affected with moisture intake up to 300 ppm, where as the moisture present in mineral oil (MO) has very deleterious impact on its properties (CIGRE WG A2-35 Brochure, 2010). The use of vegetable oil in combination with cellulose in transformer helps in drying out the later as it absorbs its moisture when in contact (Martin, 2010). Several groups of investigators (Perrier et al., 2004; Beroual et al., 1998; Rapp et al., 2009; Dang et al., 2012) have reported higher power frequency breakdown strength of conola oil as compared to mineral oil.

On the other hand, a number of studies on traditional mineral oil were published (Lesaint and Massala, 1998; Massala and Lesaint, 2001; Linhjell et al., 1994; Torshin, 2003, 2009; Lopatin et al., 1998) describing the streamer initiation and propagation in terms of velocity and shape, streamer mechanism and streamer modeling.



**Figure 4.** Streamer onset in Canola oil under negative lightning impulse voltage.

It is acknowledged that impulse pre-breakdown and breakdown characteristics are related to chemical composition of the liquid, so application of esters (with composition different to mineral oil) calls for detailed investigation under impulse voltage. Some papers on this topic were reported in Badent et al. (2000) and Duy et al. (2009). Streamer stopping length, propagation velocity, 50% breakdown voltage and acceleration voltage of natural ester (rape-seed oil) were also documented, which showed easier propagation of streamers in ester and consequently lower breakdown voltage than mineral oil. Hestac et al. (2004) reported the streamer inception voltages of rape-seed oil at 8 and 20 mm tip-plane gaps, were about 50% lower than that of mineral oil. Streamer initiation in a synthetic ester (Midel 7131) under strong non-uniform field was studied in Viet-Hung et al. (2012) which was found to be about 60% higher than that of mineral oil.

### **Streamer patterns in canola oil**

#### ***Negative polarity streamer***

At first the approximate breakdown level of the oil gap was determined and then starting from around 70% of this voltage level, the applied voltage three consecutive shots were applied at each set level. If no event was observed, the voltage was increased in steps of 2 kVp. The streamer initiation voltage ( $V_i$ ) was registered if it appeared under all three applied shots. At the onset, a faint minuscule light appears in the vicinity of the point electrode as shown in Figure 4. With an increase in voltage, it expanded with instabilities appearing on its surface as shown in Figure 5b. One or two of the instabilities enlarged with increase in voltage and propagated toward the plane electrode. As the streamers increased in size, more filaments appeared as off-shoots from these enlarged filaments as shown in a sequence of

events captured independently at different intervals as shown in Figure 5b-g. Figure 5g displays the breakdown event as captured at well above the breakdown voltage level which it impinged on the plane electrode.

It is clear that as the voltage is increased, more number of luminous branches appears and was propagated towards the plane electrode. The first one which came in contact with the plane electrode caused a flow of large current leading to the formation of a plasma channel which emanates strong intensity light. This channel was also clearly seen in this image. Since the picture captured was in 2-dimensions while the streamer pattern propagated in 3-dimensions the filaments that were closer to the observation system appeared brighter while the ones that were away from the observation point exhibited less luminosity. It is to be noted here that the streamer propagating in mineral oil were less branched and more luminous than observed in Canola oil.

#### ***Positive polarity streamer***

It was more difficult to capture the initiation event of streamers under positive polarity lightning impulses. The reason is that the streamers once initiated, propagate very swiftly with long branches. Figure 6 exhibits a white spot which indicated initiation of a positive streamer. It was much brighter than the initial initiation spot that was observed in the vicinity under negative impulses point electrode. As soon as the voltage was increased to the next step, large size filaments appeared and propagated much faster compared to streamers under negative polarity. Figure 7b-f show propagated streamer shapes captured with increasing voltage.

In case of the positive streamer, a single large streamer with bright luminosity resulted in the breakdown of the gap as shown in Figure 7g and it was observed to exert a much stronger shock-wave than the corresponding

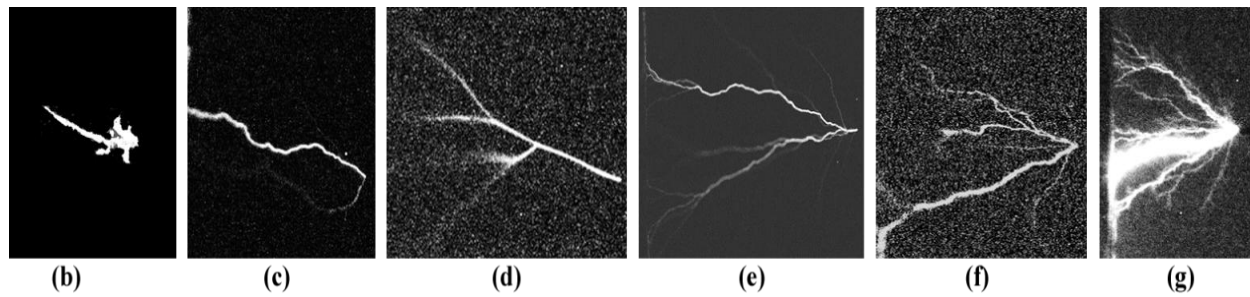

**Figure 5.** Sequence of initiation and propagation of negative streamers in vegetable oil. Electrode gap = 20 mm; Point tip radius = 10  $\mu\text{m}$  (b)  $V = 65$  kVp, (c)  $V = 73$  kVp, (d)  $V = 75$  kVp, (e)  $V = 85$  kVp, (f)  $V = 90$  kVp, (g) Breakdown event at -97 kVp.

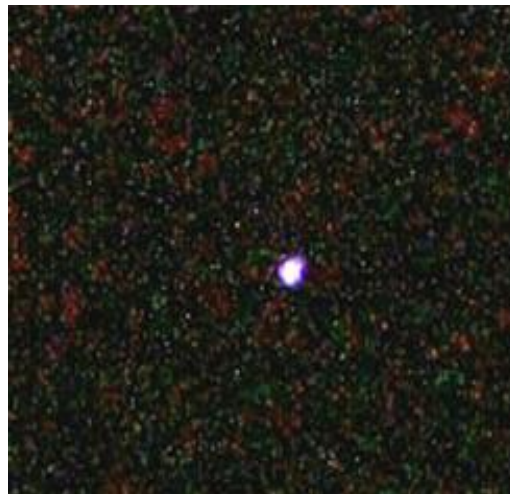

**Figure 6.** Positive streamer onset.

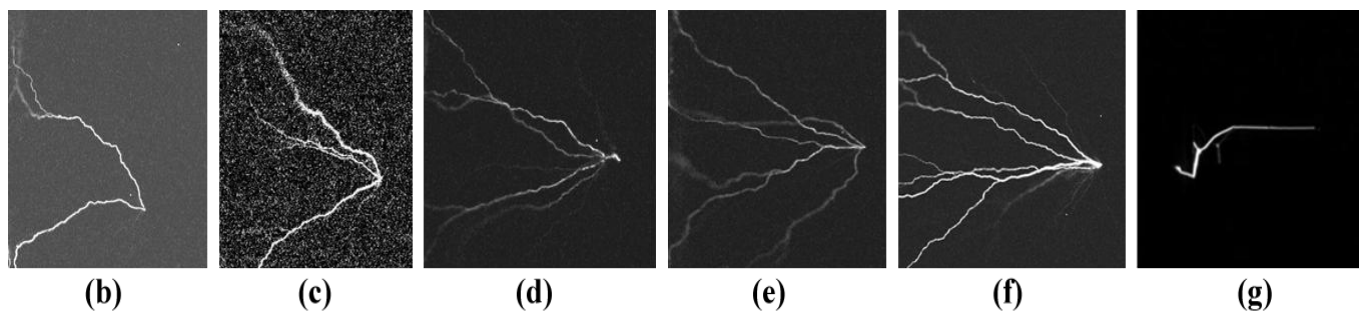

**Figure 7.** Sequence of initiation and propagation of positive streamers in vegetable oil. Electrode gap = 20 mm; point tip radius = 10  $\mu\text{m}$  (b)  $V=57$  kVp (c)  $V=62$  kVp, (d)  $V=70$  kVp, (e):  $V=81$  kVp, (f):  $V=83$  kVp, (g) Breakdown streamer at  $V=98$  kVp.

negative streamer breakdown. It was also observed that the positive streamers, both in mineral oil as well as Canola oil were filamentary and less branched than the negative streamers.

Furthermore, in case of canola oil the streamers propagated to longer lengths and they were faster, especially once they cross the mid-gap spacing. These observations suggest that positive streamers in Canola

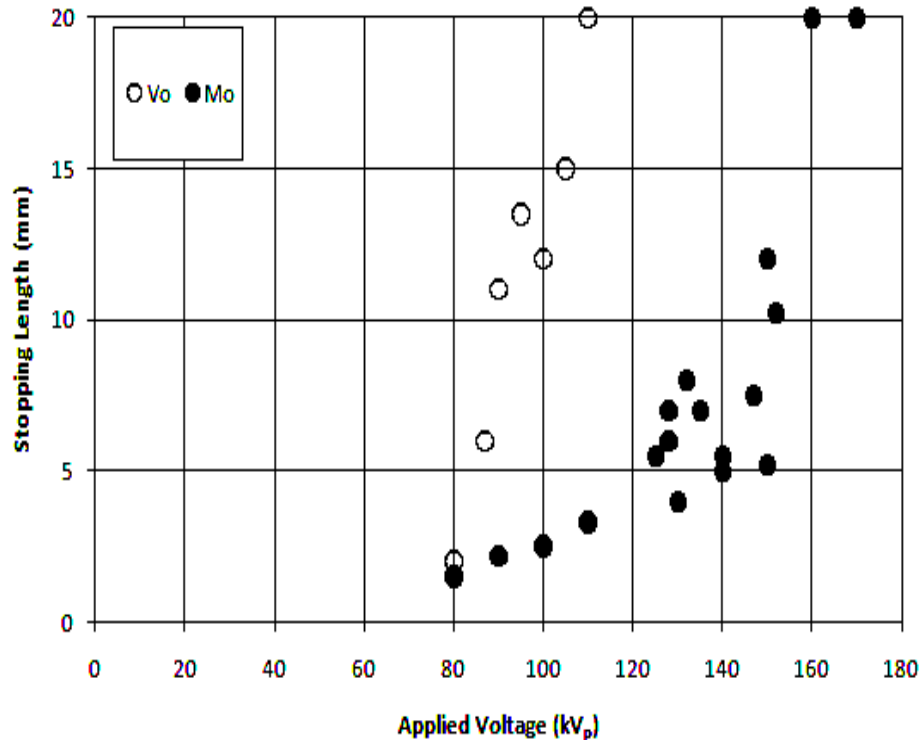

**Figure 8.** Final stopping lengths of negative streamers in Canola and mineral oils as a function of applied voltage. Gap spacing = 20 mm; point tip radius = 10  $\mu$ m.

oil underwent different propagation modes as compared to these in mineral oil. However, this observation needs further experimental studies in order to isolate the occurrence of these differing modes and the shapes of associated streamers.

### Stopping lengths of streamers

Figure 8 displays the comparison of final stopping lengths ( $L_f$ ) of streamers under the application of preset voltage impulses of negative polarity lightning impulses for canola oil and mineral oil. These lengths were measured as the axial distance from the point electrode to the plane electrode. In case of mineral oil, the  $L_f$  increases almost linearly up to a voltage level of about 125 kV<sub>p</sub>, where after, a large scatter was observed in the  $L_f$  values over the applied voltage range of 125 to 147 kV<sub>p</sub>. Beyond this voltage level the  $L_f$  tends toward a very rapid rise up to breakdown voltage level of the gap. This was consistent with the results reported earlier by Dang et al. (2012) for mineral oil under similar gap configuration and by Liu et al. (2009) in 50 mm gap spacing. Moreover, from Figure 8, it was also observed that mineral oil had an exponential increase

in applied voltage against the increase of stopping length.

This certainly explains that with the rise in voltage amplitude the negative streamer undergoes three different modes of propagation. The first mode in which the  $L_f$  propagates with lower velocity is generally confined to a gap range of about 0.3 d (where d = gap spacing). The second mode consists of medium velocity and displays large scatter in  $L_f$  values and occurs in the gap range of 0.3 to 0.5 d. Beyond the gap range of 0.5 d, the negative streamers propagate at much faster speed.

In Canola oil, too, the slower mode was confined in gap spacing of about 0.3 d. However, in this case, the second mode was not present, since the  $L_f$  values increased rapidly with further increase in the voltage. At a fixed voltage level, the  $L_f$  values in Canola oil were comparatively much longer than in mineral oil. This is why the negative polarity breakdown voltage of mineral oil was about 40% higher than in the Canola oil. This effect is opposite to AC breakdown voltage values reported in Table 1, where the AC breakdown voltage of Canola oil was almost 27% higher than in MO. However, its higher permittivity ( $\epsilon_r = 3.1$ ) which is comparable to transformer press board ( $\epsilon_r = 3.7$ ) and its typical hydrophilic character shall impose much beneficial effect

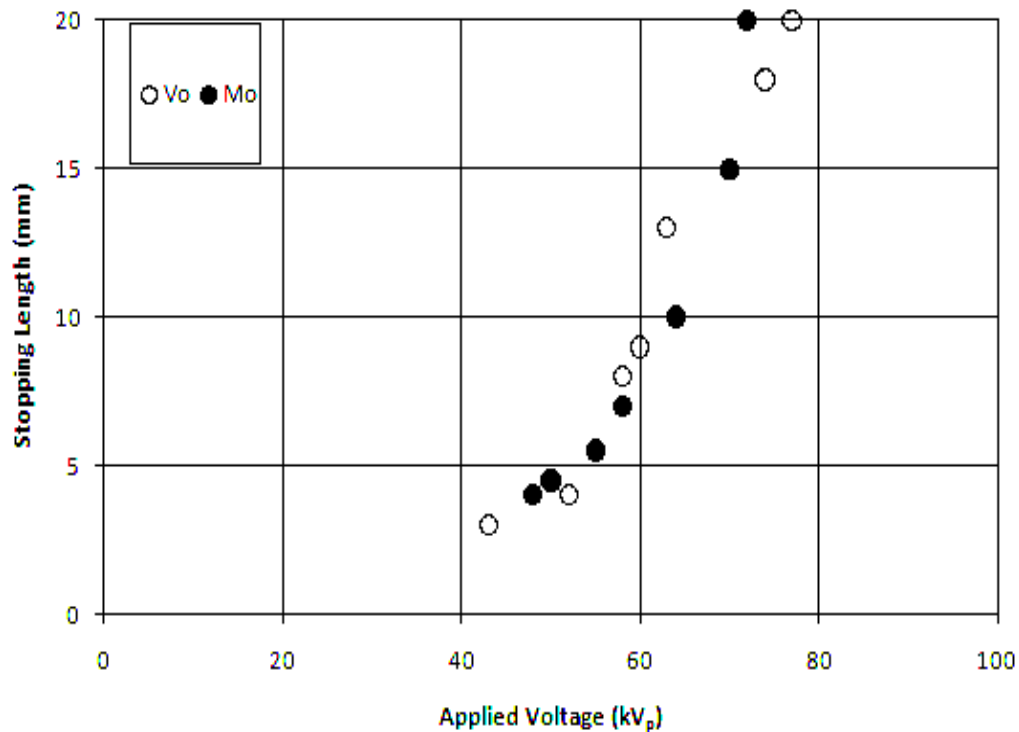

**Figure 9.** Final stopping lengths of positive streamers in Canola and mineral oils as a function of applied voltage. Gap spacing = 20 mm; point tip radius = 10  $\mu$ m.

on the drying of cellulose and thus shall provide an offset toward its lower impulse breakdown strength. Therefore, by this experimental study, it could be concluded that Canola oil can be further refined to come at par with mineral insulating oil's properties and could be used as a good "Green Insulating Oil".

It has been reported earlier in their pioneer work by Devins et al. (1981) and later by others (Yasuda et al., 2010; Chadband and Sufian, 1985; Nelson, 1980; Kelley and Hebner, 1981) that the electron affinity of liquid molecules played a dominant role in the propagation of streamers. The molecule of Canola oil contains three esters ( $-C OOR$ ) which have electro-negative oxygen atoms. These atoms may be the source behind swift propagation of negative streamers as well as for more branches that emanated from the initiated streamer trunk, as portrayed in Figure 5.

Figure 9 compared the  $L_f$  values of positive streamers as a function of applied voltage for both investigated oils. The streamer length versus transitions observed under negative polarity was not distinct under positive polarity. Moreover, the increase in  $L_f$  values with increase in the applied voltage was almost similar in both oils. Small scatter was noticed in  $L_f$  values but it was present in both oils. Moreover, it could also be observed that in positive streamer, both canola

and mineral oil had a linear increase in applied voltage with respect to stopping length. The transition in this case occurred, around 56 kV<sub>p</sub>. Under positive polarity lightning impulses, the streamers propagate much faster than under negative polarity, while their more luminous filaments indicated that they were more conducting than their negative counterparts. Whereas several negative streamer filaments impinge on plane electrode at the breakdown, only one filament of the positive streamer that came in contact with the plane electrode became very luminous and caused a breakdown. Its stem remained initially bluish but this bluish color changed to bright white color in time as well as with the increase in the applied voltage. This aspect of positive streamer needs further investigations using a faster optical event capturing system.

As the negative or positive streamer propagates in the gap it traversed with certain velocity. Moreover, the voltage drop ( $\Delta V$ ) across the length of the streamer from the point electrode to the streamer head caused it to finally stop. Therefore, it depended on the local field at the point electrode as well as the mean electric field in the inter-electrode gap. The average field in the streamer could be evaluated from the ( $L_f - V$ ) characteristics of streamers in each oil and for each polarity of the applied voltage. Thus, average



longitudinal electric field ' $E_t$ ' within the streamer channel followed the relation  $E_t = \Delta V / \Delta L_f$ . The deduced value of  $E_t$  for positive streamers for both oils was about 1.6 MV/m, whereas it was about 2.0 MV/m for the faster mode and around 6 MV/m for the slower negative streamer's mode observed near the inception in the mineral oil. Interestingly,  $E_t$  value for faster mode of negative streamers in Canola oil approached close to that of positive streamer values. The lower  $E_t$  values indicated that these streamers were more conducting. It is a well known fact that the more conducting the streamer, the more rapid it propagated through the electrode gap (Beroual et al., 1998; Badent et al., 2000; Devins et al., 1981; Nelson, 1980).

## Conclusions

This paper has reported on streamer initiation and their propagation in seed based Canola oil and mineral insulating oil used in transformers. This study leads to the following main conclusions:

1. Negative polarity streamers in Canola oil were more branched than in mineral oil.
2. Propagation of negative streamers in mineral oil exhibit three distinct modes, whereas only two modes were detected in canola oil.
3. The streamer stopping length in Canola oil for the same voltage was much longer than in mineral oil. This leads to lowering of the impulse breakdown strength of Canola oil as compared to the mineral oil.
4. The conductivity of positive streamers was higher than those of negative streamers in both oils, while the stopping lengths of those streamers were almost close to each other in both liquids.
5. Positive streamers were less branched than negative streamers.
6. The AC breakdown strength of Canola oil was 27% higher than mineral oil but it was 40% lower under lightning impulse voltage.

However, it is tough to explicitly declare that Canola oil is better than mineral oil. But from the given set of experiment and results, it has been found that canola oil has high potential to be used in transformers. These results also support a statement and new area of research that slight alteration in the properties of canola oil can produce significant improvement and could be perfectly suitable for transformers.

## Conflict of Interest

The author(s) have not declared any conflict of interest.

## ACKNOWLEDGEMENTS

The Authors are thankful to Saudi Aramco Chair in Electrical Power, Department of Electrical Engineering, King Saud University, for the technical and financial support extended for this research project.

## REFERENCES

- Amanullah M, Islam S, Chami S, Ienco G (2005). "Analyses of electro-chemical characteristics of vegetable oils as an alternative source to mineral oil-based dielectric fluid," in IEEE Int. Conf. Dielectric Liquids, 2005, pp. 397–400.
- Badent R, Hemmer M, Konekamp U, Julliard Y, Schwab A (2000). "Streamer inception field strengths in rape-seed oils," in Annual Report Conference on Electrical Insulation and Dielectric Phenomena, 2000, vol. 1. IEEE, 2000, pp. 272–275.
- Beroual A, Zahn M, Badent A, Kist K, Schwabe A, Yamashita H, Yamazawa K, Danikas M, Chadband W, Torshin Y (1998). "Propagation and structure of streamers in liquid dielectrics," IEEE Elect. Insul. Magazine 14(2):6–17.
- Chadband W, Sufian T (1985). "Experimental support for a model of positive streamer propagation in liquid insulation," IEEE Trans. Electr. Insul. 2:239–246.
- CIGRE WG A2-35 Brochure, No. 436, October 2010.
- Claiborne C, Walsh E, Oommen T (1999). "An agriculturally based biodegradable dielectric fluid," in IEEE Trans. Distribution Conf. 2:876–881.
- Dang V, Beroual A, Perrier C (2012). "Investigations on streamers phenomena in mineral, synthetic and natural ester oils under lightning impulse voltage," IEEE Trans. Dielectrics Electr. Insul. 19(5):1521–1527.
- Devins J, Rzad S, Schwabe R (1981). "Breakdown and prebreakdown phenomena in liquids," J. Appl. Phys. 52(7):4531–4545.
- Duy CT, Lesaint O, Denat A, Bonifaci N (2009). "Streamer Propagation and Breakdown in Natural Ester at High Voltage", IEEE Trans. Dielectrics Electr. Insul. 16(6):1582-1594.
- Hestac OL, Berg G, Ingebrigtsen S, Lundgaard LE (2004). "Streamer Injection and Growth under Impulse Voltage: A Comparison of Cyclohexane, Midel 7131 and Nytro 10X", IEEE. Conf. Electr. Insul. Dielectrics Phenomena (CEIDP), Colorado, USA, pp. 542-546.
- Kelley E, Hebner R (1981). "The electric field distribution associated with pre-breakdown phenomena in nitrobenzene," J. Appl. Phys. 52(1):191–195.
- Lesaint O, Massala G (1998). "Positive streamer propagation in large oil gaps: Experimental Characterization of Propagation Modes", IEEE Trans. Dielectrics Electr. Insul. (3):360-370.
- Linhjell D, Lundgaard L, Berg G (1994). "Streamer propagation under impulse voltage in long point-plane oil gaps", IEEE Trans. Dielectrics Electr. Insul. 1(3):447-458.
- Liu Q, Wang Z, Perrot F (2009). "Impulse breakdown voltages of ester-based transformer oils determined by using different test methods," in IEEE Conf. Electr. Insul. Dielectric Phenomena, CEIDP'09, IEEE, 2009, pp. 608–612.
- Lopatin V, Noskov MD, Badent R, Kist K, Schwab AJ (1998). "Positive discharge development in insulating oil: optical observation and simulation", IEEE Trans. Dielectrics Electr. Insul. 5(2):250-255.
- Martin D, Wang Z (2008). "Statistical analysis of the ac breakdown voltages of ester based transformer oils," IEEE Trans. Dielectrics Electr. Insul. 15(4):1044–1050.
- Martin MAG (2010). "Vegetable oils, and alternative to mineral oil for power transformers", IEEE Electrical Insulation Magazine, 26(6):7-13.
- Massala G, Lesaint O (2001). "A comparison of negative and positive streamers in mineral oil at large gaps", J. Phys. D: Appl. Phys. 34(10):1525-1532.
- McShane C, Corkran J, Harthun R, Gauger G, Rapp K, Howells E (2000). "Vegetable oil based dielectric coolant," Mar. 14 2000, US

- Patent 6,037,537.
- McShane CP, Gauger GA, Luksich J (1999). "Fire Resistant Natural Ester Dielectric Fluid and Novel Insulation System for its Use. Proc. of IEEE/PES Transmission and Distribution Conference, 1999.
- Moumine I, Gosse B, Gosse J, Clavreul R, Hantouche C (1995). "Vegetable oil as an impregnant in hv ac capacitors," in IEEE 5th Int. Conf. Conduction Breakdown Solid Dielectrics, ICSD'95, 1995, pp. 611–615.
- Nelson J (1980). "Insulating liquids: Their uses, manufacture and properties," *Electronics Power* 26(6):481.
- Oommen T (2002). "Vegetable oils for liquid-filled transformers," *IEEE Electrical Insul. Magazine*, 18(1):6–11.
- Oommen T, Claiborne C (1999). "Electrical transformers containing electrical insulation fluids comprising high oleic acid oil compositions," Sep. 7 1999, US Patent 5,949,017.
- Perrier C, Beroual A, Bessede J (2004). "Experimental investigations on different insulating liquids and mixtures for power transformers," in Conference Record of the IEEE Int. Symposium Electrical Insul. pp. 237–240.
- Rapp K, Corkran J, Mcshane C, Prevost T (2009). "Lightning impulse testing of natural ester fluid gaps and insulation interfaces," *IEEE Trans. Dielectrics Elect. Insul.* 16(6):1595–1603.
- Sharbaugh A, Devins J, Rzad S (1978). "Progress in the field of electric breakdown in dielectric liquids," *IEEE Trans. Elect. Insul.* 4:249–276.
- Stockton DP, Bland JR, McClanahan T, Wilson J, Harris DL, McShane P (2007). "Natural Ester Transformer Fluids: Safety, Reliability & Environmental Performance," *Petroleum and Chemical Industry Technical Conf. (PCIC '07):* 1-7.
- Torshin YV (2003). "Prediction of Breakdown Voltage of Transformer Oil from Predischarge Phenomena", *IEEE Trans. Dielectrics Electr. Insul.* 10(6):933-941.
- Torshin YV (2009). "Initiation and propagation of the negative leader in transformer oil under impulse voltage", *IEEE Trans. Dielectrics Electr. Insul.* 16:1536-1542.
- Viet-Hung D, Beroual A, Perrier C (2012). "Investigation on streamers phenomena in mineral, synthetic and natural ester oils under lightning impulse voltage", *IEEE Trans. DEI.* 19(5):1521-1527.
- Yasuda K, Arazoe S, Igarashi T, Yanabu S, Ueta G, Okabe S (2010). "Comparison of the insulation characteristics of environmentally-friendly oils," *IEEE Trans. Dielectrics Elect. Insul.* 17(3):791–798.