

*Full Length Research Paper*

# Second law based optimization of a plate fin heat exchanger using Imperialist Competitive Algorithm

Moslem Yousefi<sup>1\*</sup>, Amer Nordin Darus<sup>1</sup> and Hossein Mohammadi<sup>2</sup>

<sup>1</sup>Faculty of Mechanical Engineering, Universiti Teknologi, Malaysia.

<sup>2</sup>Faculty of Computer Science, Universiti Teknologi, Malaysia.

Accepted 22 April, 2011

**This study explores the application of Imperialist Competitive Algorithm (ICA) in thermodynamic optimization of a cross-flow plate fin heat exchanger. The optimization aims at finding the minimum number of total entropy generation units under a given heat duty and pressure drop constraints. Seven design parameters namely, hot side length, cold side length, fin height, fin frequency, fin thickness, number of fin layers for hot side and offset-strip length are chosen as optimization variables. The constraints are handled using penalty function. To better understand the algorithm, a case study from the literature is presented. The results show that ICA can find better results comparing to traditional genetic algorithms.**

**Key words:** Optimization, plate fin heat exchanger, evolutionary algorithms, imperialist competitive algorithm.

## INTRODUCTION

A plate fin heat exchanger (PFHE) is a type of compact heat exchanger (CHE) which transfer heat between fluids using plates and finned chambers. It characterise mainly with its relatively high heat transfer area to volume ratio (compactness). PFHEs are widely used in different aspects of industry from cryogenics to aerospace and automobile industry. Generally, heat exchanger design is based on trial-and-error process in which geometrical and operational parameters are selected in order of satisfying specified requirements such as outlet temperature, heat duty and pressure drop. Besides, selected parameters should lead to an optimum solution. Since there is always the possibility that the selected design parameters do not assure the optimum solution, researchers have been trying to propose methods to optimize heat exchanger parameters.

According to the literature, the common objectives in heat exchanger design are small volume (hence low weight) and low cost. Practically, a higher velocity yields to higher heat transfer coefficient which consequently leads to smaller heat transfer area and lower capital cost. It should be noticed however, that higher velocity results in higher pressure drop and power consumption too.

However, the optimization of PFHEs as a real system has not gained much attention. Since the thermodynamic optimization of any real system is associated with the second law of thermodynamics, second law based entropy generation minimization (EGM) has been introduced to assess the thermal performance of any real system which is working based on the irreversibilities due to heat and mass transfer or simply fluid flow. The number of entropy generation units ( $N_s$ ) shows the amount of power that is lost due to the irreversibility. The main sources of irreversibility in a heat exchanger are the finite temperature difference between fluid streams and pressure drops. Considering minimization of number of entropy generation units, the optimization means finding a configuration for the heat exchanger with the minimum amount of lost or unavailable power. The so-called EGM method was first introduced by Bejan (1977) in which he presented the design of a gas-to-air heat exchanger for minimum amount of irreversibility. He also presented the design of a regenerative heat exchanger for minimum heat transfer area while having constant entropy generation units. Several other works have been published on the optimization of heat exchangers considering entropy generation. Ogulata and Doba (1998), Vargas and Bejan (2001), and Iyengar and Bar-Cohen (2003) presented the optimization of flat plate-fin heat exchangers. London (1982), presented the relationship

\*Corresponding author. E-mail: [Yousefi.moslem@gmail.com](mailto:Yousefi.moslem@gmail.com).

between irreversibility and economics.

Since the design of a plate-fin heat exchanger involves searching in a large number of operating variables, and the traditional optimization methods cannot perform accurately, in recent years the application of evolutionary algorithms has gained much attention in design of heat exchangers. Pacheco-Vega et al. (1998) used a Genetic algorithm (GA) to predict the performance of a fin-and-tube heat exchanger. Tayal et al. (1999) optimized a shell-and-tube heat exchanger under four strategies using simulate annealing (SA) GA. Selbas et al. (2006) proposed a new design method for optimization of a shell-and-tube exchanger economically. Moreover, GAs has been used to obtain heat transfer correlation for compact heat exchangers (Pacheco-Vega et al., 2003). In addition, in case of plate fin heat exchangers, Mishra et al. (2004) used a GA to optimize a PFHE under specified heat duty and given space and flow restrictions. The main objective of optimization was minimization of the total annual cost. They validated their work by comparing the optimization results of a reduced model of a two-layer heat exchanger with the solution from traditional optimization techniques. Ozkol and Komurgoz (2005) employed a GA to optimize geometry of a heat exchanger with respect to minimizing the ration of number of heat transfer units (NTU) to the cold side pressure drop. Xie et al. (2008) utilized a GA to optimize a compact heat exchanger. Two objectives namely minimum total volume or/and total annual cost were studied, three shape parameters were considered as variables while the geometries of the fins were fixed. Peng and Ling (2008) used a GA combined with back propagation neural networks (BP) to optimize a PFHE. The main objectives were total weight and total annual cost for a given constrained conditions. Mishra et al. (2004) utilized a GA in order of optimizing a PFHE with offset-strip fins with the aim of minimizing the number of entropy generation units for a specified heat duty and given space restrictions. Beside single objective optimizations, some works aimed at multi-objective optimization. Multi-objective optimization procedure results in Pareto front solutions, that is, a set of optimal solutions, in which every one of them is a trade-off between objectives and can be selected by the user regarding the application. Najafi and Najafi (2010) developed a multi-objective GA to obtain a set of design geometrical parameters to achieve two conflicting objectives, namely minimum pressure drop and maximum overall heat transfer coefficient. Sanaye and Hajabdollahi (2010) applied Fast and elitist non-dominated sorting genetic-algorithm (NSGA-II) to achieve maximum effectiveness and the minimum total annual cost two objective functions. In case of other evolutionary algorithms, Peng et al. (2010) used a Particle Swarm Optimization (PSO) to optimize a PFHE. They considered minimization of total annual cost, total weight under given constrained conditions, respectively. Comparing their

result to the traditional gas, they demonstrated that PSO presents shorter computational time and better results for their case. Also, Rao and Patel (2010) employed a PSO to optimize a cross-flow plate fin heat exchanger with the aim of minimizing the entropy generation units, total volume and total annual cost respectively.

Obviously, the social and intellectual evolution of human being is taking place far faster than their genetic and physical evolution, therefore some evolutionary algorithms have implemented the cultural aspect of human life to achieve faster convergence rate and better results. Since the majority of known evolutionary algorithms are based on the simulation of natural and biological processes, Atashpaz-Gargari and Lucas (2007) proposed imperialist competitive algorithm (ICA) which is an evolutionary algorithm based on human's socio-political evolution. In view of the fact that this evolutionary optimization algorithm has shown great performance in both convergence rate and achieving better global optima, ICA has been successfully utilized in many engineering applications such as control (Lucas et al., 2010), data clustering (Niknam et al., 2011), industrial engineering (Nazari-Shirkouhi et al., 2010) in recent years. However, to the best knowledge of the authors, ICA has not been implemented in thermal engineering problems. Therefore, in the present work an attempt is made to put the entropy generation minimization and Imperialist Competitive Algorithm into the design of a plate fin heat exchanger. The primary concern of the work is to check the feasibility of the ICA as a promising method in optimizing heat transfer problems.

## THERMAL MODELLING AND OBJECTIVE FUNCTION

A schematic of a typical cross-flow plate fin heat exchanger with offset strip fin can be seen in Figure 1. In the analysis, for the sake of simplicity, the variation of physical property of fluids with temperature is neglected where both fluids are considered to be ideal gases. Other assumptions are as follows:

- 1) Number of fin layers for the cold side ( $N_b$ ) is assumed to be one more than the hot side ( $N_a$ ). It is a conventional way in design of heat exchangers in order to avoid heat waste to the ambient.
- 2) Heat exchanger is working under steady state condition.
- 3) Heat transfer coefficient and the area distribution are assumed to be uniform and constant.
- 4) The thermal resistance of walls is neglected.
- 5) Since the influence of fouling is negligibly small for a gas-to-gas heat exchanger, it is neglected.

$$N_s = \frac{\dot{S}}{C_{max}} \quad (1)$$

Entropy generation rate for two fluid streams is calculated as:

$$\dot{S} = m_a (\Delta S_a) + m_b (\Delta S_b) \quad (2)$$

Using the methodology of Bejan (1977), the above equation gives:

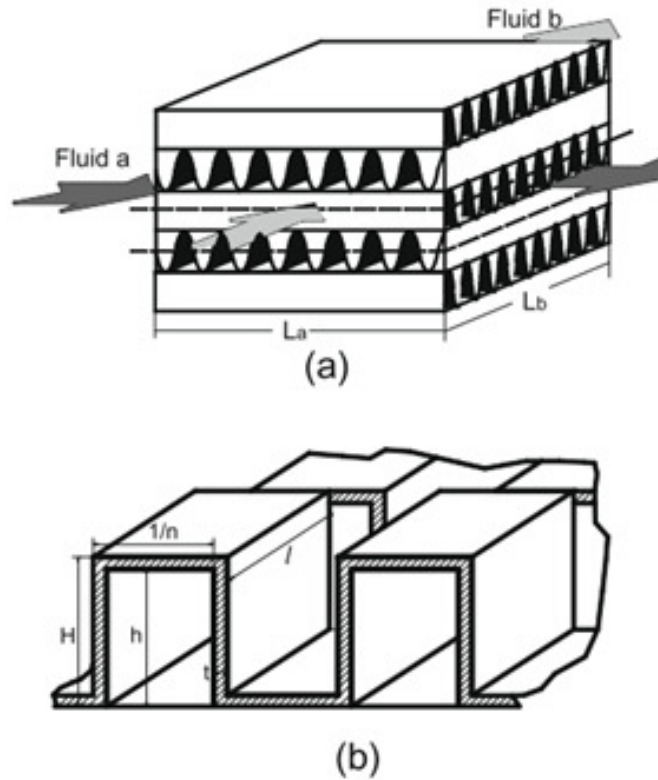

**Figure 1.** (a) Schematic representation of cross-flow plate-fin heat exchanger, and (b) detailed view of offset-strip fin.

$$\dot{S} = m_a \left[ C_p \ln \frac{T_{a2}}{T_{a1}} - R_a \ln \frac{P_{a2}}{P_{a1}} \right] + m_b \left[ C_p \ln \frac{T_{b2}}{T_{b1}} - R_b \ln \frac{P_{b2}}{P_{b1}} \right] \quad (3)$$

$T_{a,2}$  and  $T_{b,2}$  are outlet temperatures in hot and cold sides respectively, and that was calculated knowing the heat exchanger efficiency,  $\varepsilon$ . The outlet fluids pressures in hot and cold sides,  $P_{a,2}$  and  $P_{b,2}$  are determined as follows

$$P_{a,2} = P_{a,1} - \Delta P_a \quad (4)$$

$$P_{b,2} = P_{b,1} - \Delta P_b \quad (5)$$

In the present work, since the outlet temperature of the fluids is not specified the  $\varepsilon - NTU$  method is used for rating performance of the heat exchanger in the optimization process. The effectiveness of cross-flow heat exchanger, for both fluids unmixed (Incropera and Dewitt, 2010) is proposed as

$$\varepsilon = 1 - \exp \left[ \left( \frac{1}{Cr} \right) NTU^{0.22} \{ \exp[-Cr \cdot NTU^{0.78}] - 1 \} \right] \quad (6)$$

In this equation,  $Cr = C_{min}/C_{max}$ . Neglecting the thermal resistance of the walls and fouling factors, NTU is calculated as follows

$$\frac{1}{UA} = \frac{1}{(hA)_a} + \frac{1}{(hA)_b} \quad (7)$$

$$NTU = \frac{UA}{C_{min}} \quad (8)$$

Heat transfer coefficient is calculated from Colborn factor  $j$ .

$$h = j \cdot G \cdot C_p \cdot Pr^{-\frac{2}{3}} \quad (9)$$

In this formula,  $G = \frac{\dot{m}}{A_{ff}}$ , where  $A_{ff}$  is free flow cross-sectional area that can be calculated considering the geometrical details in Figure 1.

$$A_{ffa} = (H_a - t_a)(1 - n_a t_a) L_b N_a \quad (10)$$

$$A_{ffb} = (H_b - t_b)(1 - n_b t_b) L_a N_b \quad (11)$$

$$A_a = L_a L_b N_a [1 + 2n_a (H_a - t_a)] \quad (12)$$

$$A_b = L_a L_b N_b [1 + 2n_b (H_b - t_b)] \quad (13)$$

Then, total heat transfer area is given by:

$$A_{HT} = A_a + A_b \quad (14)$$

Heat transfer rate is calculated as follows

$$Q = \varepsilon C_{\min} (T_{a,1} - T_{b,1}) \quad (15)$$

Frictional pressure drop in both sides is given by:

$$\Delta P_a = \frac{2f_a L_a C_a^2}{\rho_a D_{h,a}} \quad (16)$$

$$\Delta P_b = \frac{2f_b L_b C_b^2}{\rho_b D_{h,b}} \quad (17)$$

There are many correlations for evaluation of Colborn factor  $j$  and Fanning factor  $f$  for offset strip fin. Equations (13) and (14) present the correlation by Manglik and Bergles (1995) used in this work.

$$j = 0.6522(Re)^{-0.5403} (\alpha)^{-0.1541} (\delta)^{0.1499} (\gamma)^{-0.0678} \\ \times [1 + 5.269 \times 10^{-5} (Re)^{1.34} (\alpha)^{0.504} (\delta)^{0.456} (\gamma)^{-1.055}]^{0.1} \quad (18)$$

$$f = 9.6243(Re)^{-0.7422} (\alpha)^{-0.1888} (\delta)^{0.2023} (\gamma)^{-0.2687} \\ \times [1 + 7.669 \times 10^{-5} (Re)^{4.425} (\alpha)^{0.5522} (\delta)^{2.707} (\gamma)^{0.2224}]^{0.1} \quad (19)$$

Where

$$\alpha = \frac{z}{R}, \quad \delta = \frac{t}{W}, \quad \gamma = \frac{z}{s}$$

Considering

$$s = (1/n - t) \text{ and } h = H - t \quad (20)$$

Hydraulic diameter and Reynolds number are thus defined

$$D_h = \frac{4skl}{2(sl + hl + th) + ts} \quad (21)$$

The above equations are valid for

$$120 < Re < 10^4, 0.134 < \alpha < 0.997, 0.012 < \delta < 0.048 \text{ and } 0.041 < \gamma < 0.121$$

These equations correlate  $j$  and  $f$  factors from experimental data within +20% accuracy in all flow regimes namely laminar, transition and turbulence; there is no need to describe the flow regime for a specified operating condition and hence very useful in most practical applications.

In the present work, the objective is to find the configuration associated with the minimum number of entropy generation unit. In summary, the optimization problem at hand is a large-scale, combinatorial problem which deals with both continuous and discrete variables. For optimization problem, ICA is used for a constrained minimization. The problem can generally be stated as follows

$$\text{Minimise } f(X), \quad X = [x_1, \dots, x_k] \quad (22)$$

Where constraints are stated as

$$g_j(X) \leq 0, \quad j = 1, \dots, m \quad (23)$$

and

$$x_{i,\min} \leq x_i \leq x_{i,\max}, \quad i = 1, \dots, k \quad (24)$$

To handle the constraints in the optimization algorithm, a penalty function is added to the objective function which converts the unconstrained problem to a constrained one.

$$\text{Minimise } f(x) + \sum_{j=1}^m \phi(g_j(X)) \quad (25)$$

Subject to

$$x_{i,\min} \leq x_i \leq x_{i,\max}, \quad i = 1, \dots, k \quad (26)$$

Where  $\phi$  is a penalty function defined as

$$\phi(g(X)) = R1 \cdot (g(X))^2 \quad (27)$$

$R1$  is the penalty parameter which comparing to the  $f(x)$  have a relatively large value.

## IMPERIALIST COMPETITIVE ALGORITHM

Figure 2 depicts a schematic view of the proposed algorithm. Similar to the other evolutionary algorithms, the proposed algorithm starts by an initial population. In this algorithm each individual of the population is called a country. There are two types of countries, namely Imperialist and Colony. Depending on its power, each Imperialist colonized some of the countries. The main processes of this algorithm are assimilation and competition. The total power of an empire depends on both the power of imperialist country and its colonies. In fact, each empire's total power is considered as the sum of total power of the imperialist country and an arbitrary percentage of its colonies' mean power.

After formation of the initial empires, the imperialistic competition between them starts. Any empire which cannot increase its power in the competition or at least preserve its colonies would be eliminated eventually. To increase their powers, Imperialists have to try to develop their colonies.

Following some decades, the power difference between the Imperialists and their colonies will be less and convergence would occur. Basically the imperialist competition can be continued until there would be only one empire in the search space. In this situation the colonies are similar to the imperialist regarding their powers. In any optimization problem the goal is to find an optimal solution in terms of the problem variables. An array of the problem variables is formed which is called Chromosome in GA and country in this proposed algorithm.

The initial empires are demonstrated in Figure 3. As can be seen in this figure, more powerful empires have greater number of colonies; in addition it is seen that imperialist 1 has created the most powerful empire and therefore has the greatest number of colonies.

### Assimilation policy: Movement of colonies towards the imperialist

One of the most important processes of this algorithm which leads the countries move towards their imperialist is called assimilation

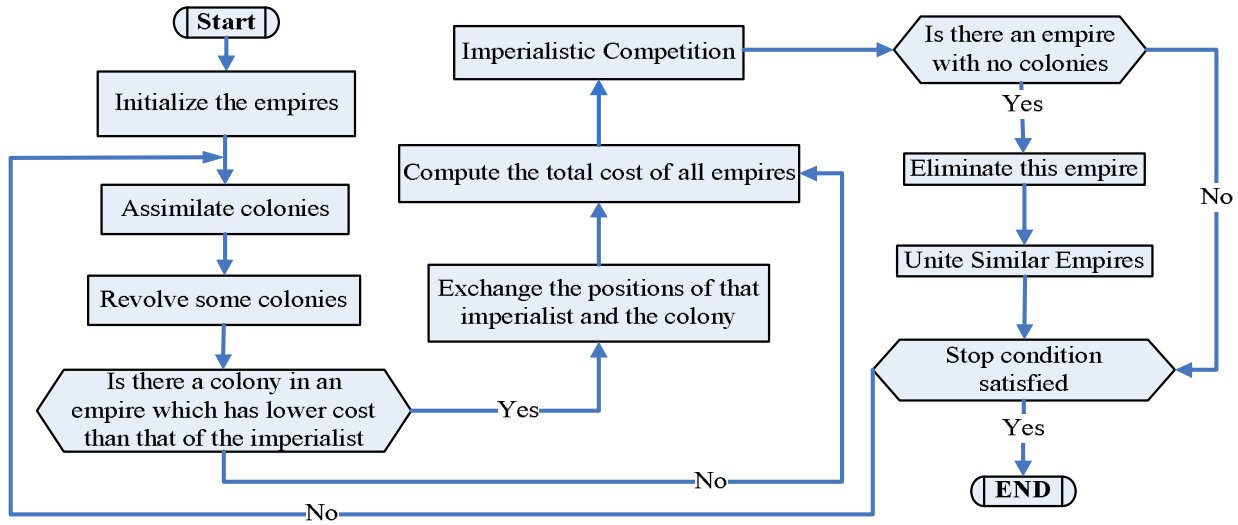

Figure 2. Flowchart of the Imperialist Competitive Algorithm.

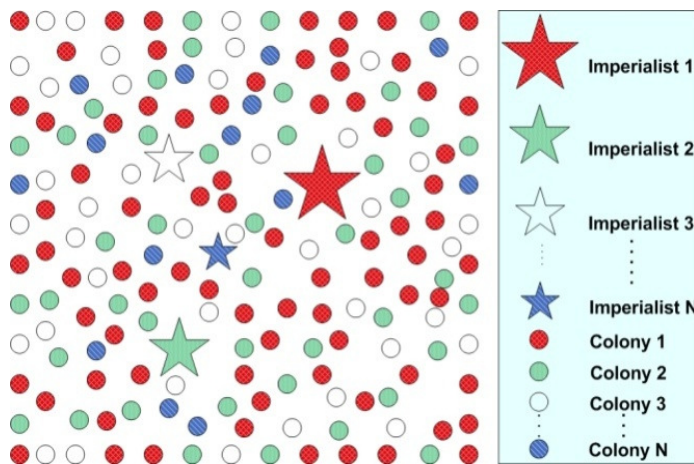

Figure 3. Generating the initial empires: The more colonies an imperialist possess, the bigger is its relevant ★ mark.

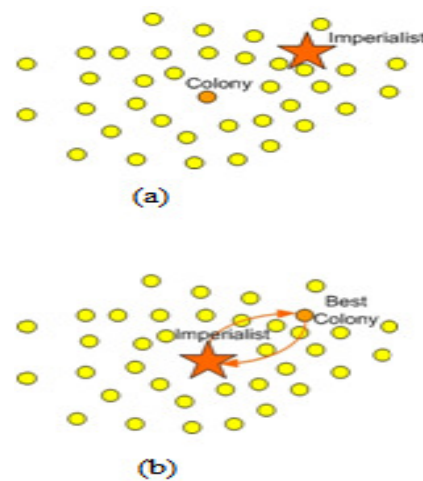

Figure 5. (a) Exchanging the positions of a colony and the imperialist (b) The entire empire after position exchange.

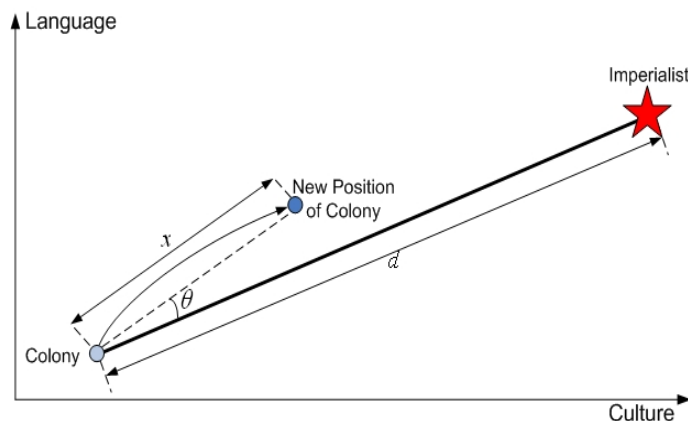
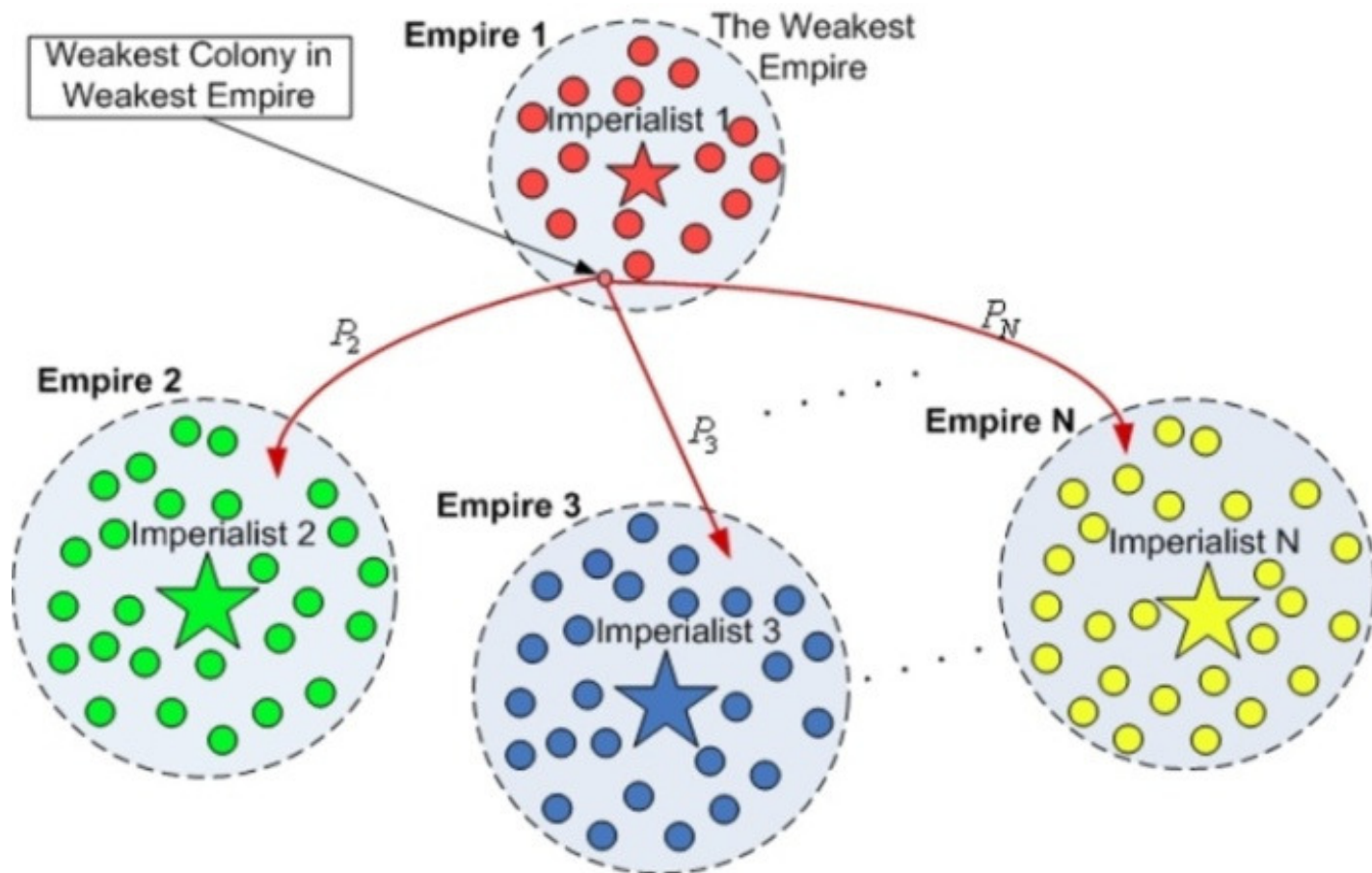

Figure 4. Movement of colonies toward their relevant imperialist in a randomly deviated direction.

policy. A schematic description of this process is demonstrated in Figure 4.

The colony is drawn by imperialist in the culture and language axes. After applying this policy the colony will get closer to the imperialist in the mentioned axes. In assimilation, each colony moves on the line that connects the colony and its imperialist by  $x$  units, Where  $\theta$  and  $x$  are random numbers with uniform distribution and  $\beta$  is a number greater than one and  $d$  is the distance between the colony and the imperialist state.  $\beta > 1$  causes the colonies to get closer to the imperialist state from both sides.

As the colonies are moving towards the imperialist, there is a possibility that some of these colonies reach a better position than the imperialist; in this situation the colony and its respective imperialist change their positions. Then the algorithms will be continued using this new country as the imperialist. Figure 5a



**Figure 6.** Imperialistic competition: The more powerful an empire is, the more likely it will possess the weakest colony of the weakest empire.

demonstrates the position exchange between the colony and its imperialist in which the best colony of the empire is shown in a darker colour. Figure 5b depicts the position of the imperialist and the colony after the exchange.

The most important process in the ICA is imperialistic competition in which all empires try to take over the colonies of other empires. Gradually, weaker empires lose their colonies to the stronger ones. This process is modeled by choosing the weakest colony of the weakest empire and giving it to the appropriate empire based on a competition among all empires. Figure 6 demonstrate a schematic of this process.

In this Figure 6, empire 1 is considered the weakest empire whereas one of its colonies is under competition process. The empires 2 to n are competing for taking its possession. In order to begin the competition, the possession probability was calculated considering the total power of the empire.

Like the other evolutionary algorithms several conditions may be selected as termination criteria including reaching a maximum number of iterations or having no improvement in final results. In the proposed algorithm, eventually there would be only one imperialist which controls all other countries. The pseudo-code of the ICA is shown in the Figure 7.

### Case study

To clarify the application of mentioned optimization algorithm, a case study taken from the work of Shah and Sekulić (2003) is considered. A gas-to-air single pass cross-flow heat exchanger

having heat duty of 1069.8 kW is needed to be designed for the minimum number of entropy generation units. Maximum dimension of the exchanger is 1\*1\*1 m. Gas and air inlet temperatures are 900 and 200K, respectively and gas and air mass flow rates are 1.66 and 2.00 kg/s respectively. Pressure drops are set to be limited to 9.50 and 8.00 kPa. The gas and air inlet pressures are 160 and 200 kPa absolute. The offset strip fin surface is used on the gas and air sides. The plate thickness is set at 0.5 mm and is not an optimization variable. Operating conditions and the cost function constant values needed for cost evaluation are listed in Table 1.

In this study, a total number of 7 parameters namely, hot flow length ( $L_a$ ), cold flow length ( $L_b$ ), number of hot side layers ( $N_a$ ), fin frequency ( $n$ ), fin thickness ( $t$ ), fin height ( $H$ ) and fin strip length ( $l_f$ ) are considered as optimization variables. All variables except number of hot side layers are continuous. Thickness of the plate,  $t_p$  is considered to be constant at 0.5 mm and is not to be optimized. The variation ranges of the variables are shown in Table 2. Additional inequality constraints are set to guarantee that the no-flow length, pressures drop and  $\alpha$ ,  $\delta$ ,  $\gamma$  at both sides maintain their prescribed ranges. Moreover another constraint is implement to ensure that a minimum required heat transfer is achieved.

## RESULTS AND DISCUSSION

For the prescribed heat duty and allowable pressure drop, the optimization problem is finding the design variables that minimize the weight of the PFHE. The ICA

- 1) Initializing empires by selecting some random points on the function.
- 2) Assimilation (Moving the colonies toward their relevant imperialist).
- 3) Revolution (Changing the position of some colonies randomly).
- 4) Exchanging the position of the imperialist with the best colony of the empire if it has lower cost than it.
- 5) Computing the total cost of all empires.
- 6) Imperialistic competition
- 7) Eliminate the powerless empires.
- 8) Check termination criterion

**Figure 7.** Pseudo code of the Imperialistic Competitive Algorithm.

**Table 1.** Operating parameters for the case study.

Parameters	Hot side (side a)	Cold side (side b)
Mass flow rate, $m$ (kg/s)	1.66	2
Inlet temperature, $T$ (K)	900	200
Specific heat, $C_p$ (J/kg K)	1122	1073
Density, $\rho$ (kg/m <sup>3</sup> )	0.6296	0.9638
Dynamic viscosity, $\mu$ (Ns/m <sup>2</sup> )	401E-7	336E-7
Prandtl number, $Pr$	0.731	0.694
Inlet pressure, $P$ (kPa)	160	200
Maximum pressure drop, $\Delta P$ (kPa)	9.50	8.00
Heat duty, $Q$ (kW)	1069.8	

**Table 2.** Variation range of design parameters.

Parameter	Minimum	Maximum
Hot flow length ( $L_a$ ) (m)	0.1	1
Cold flow length ( $L_b$ ) (m)	0.1	1
Fin height ( $H$ ) (mm)	2	10
Fin thickness ( $t$ ) (mm)	0.1	0.2
Fin frequency ( $n$ ) (m <sup>-1</sup> )	100	1000
Fin offset length ( $l_f$ ) (mm)	1	10
Number of hot side layers ( $N_a$ )	1	200

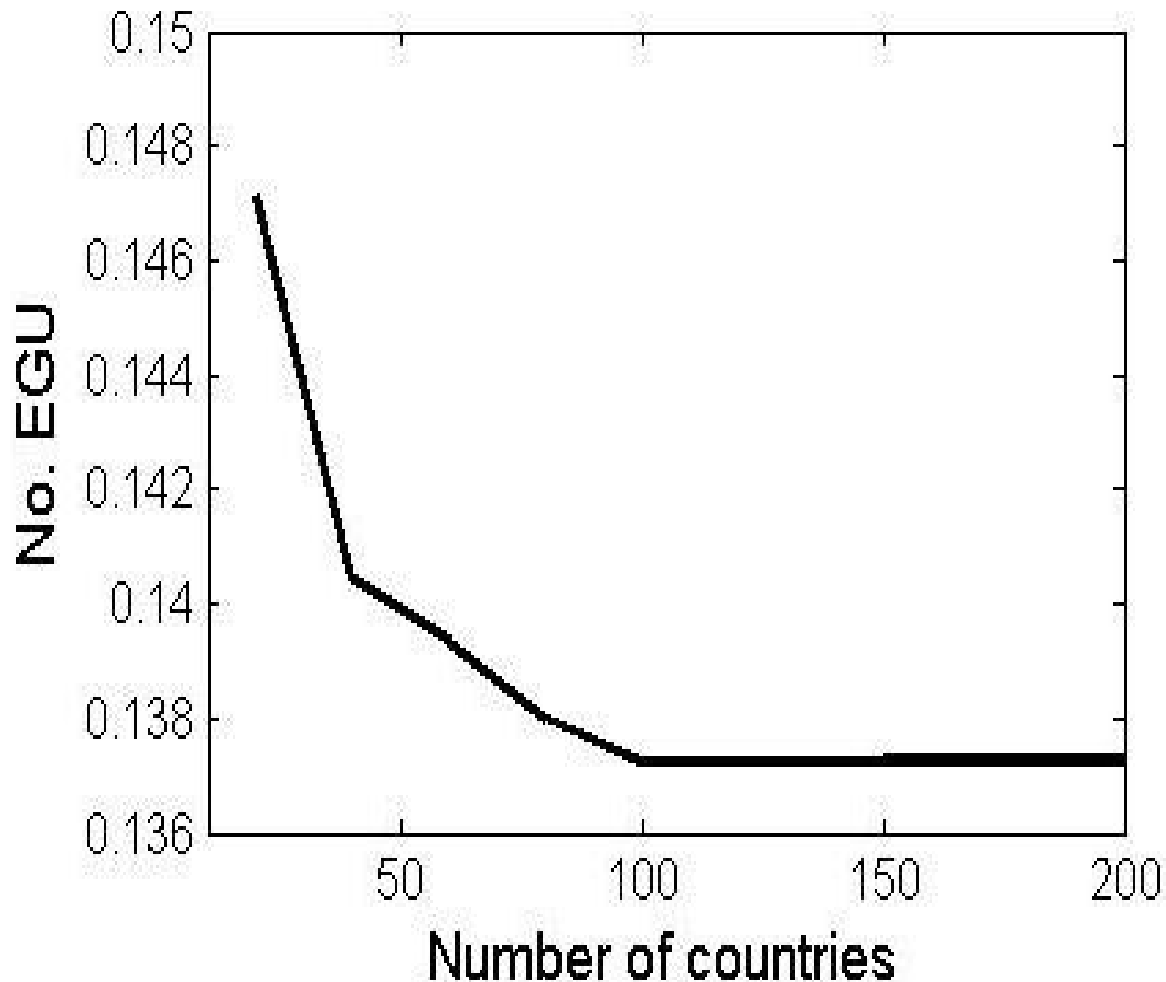

Figure 8. Effect of the variation of the number of countries on the objective function.

algorithm is used to optimize the heat exchanger subject to the mentioned constraints. ICA parameters are selected based on Atashpaz-Gargari and Lucas (2007) recommendations.  $\beta$ ,  $\gamma$  and revolution rate values are set to 2,  $\pi/4$  and 0.1 respectively. The ratio of initial imperialists to the initial countries is set to 1/10. To choose the proper number of countries for the optimization, the algorithm is run for different number of initial countries and the respected results for the minimum total weight can be seen in Figure 8. The change in the final result of the objective function is very high for the number of countries less than 50. Increasing the number of countries up to 100 slightly improves the results. Although more increase in the number of initial countries yields a decrease in the objective function, the changes is not considerable so the number of countries for this study is set to 100 for the rest of the paper.

Figure 9 demonstrates the iteration process of the ICA method. A significant decrease in the target function is seen in the beginning of the evolution process (first 10

decades). After certain decades (less than 50) the changes in the fitness function becomes very small.

Finally the minimum number of EGU of the PFHE is found to be 0.1374 after 200 decades. Table 3 shows the PFHE preliminary design and the configuration found by ICA that yields to minimum number of entropy generation units. A considerable decrease (12.8%) in the number of EGU of PFHE can be noticed comparing to the 0.1576 preliminary design. It can be observed that in the minimum weight design the fin frequency is decreased from 782 to 240 while the fin strip length is increased from 3.18 to 9.6. The pressure drop on both sides is as low as possible to decrease the amount of irreversibility as much as possible. Flow length on hot and cold sides is increased to 1 and 0.88 m respectively while no-flow length is decreased from 1 to 0.87 m.

A brief investigation is carried out to compare the design efficiency of the proposed algorithm with traditional GA. The results are demonstrated in Table 4. For the GA optimization, the crossover probability and mutation rate are set to 0.9 and 0.005 respectively similar



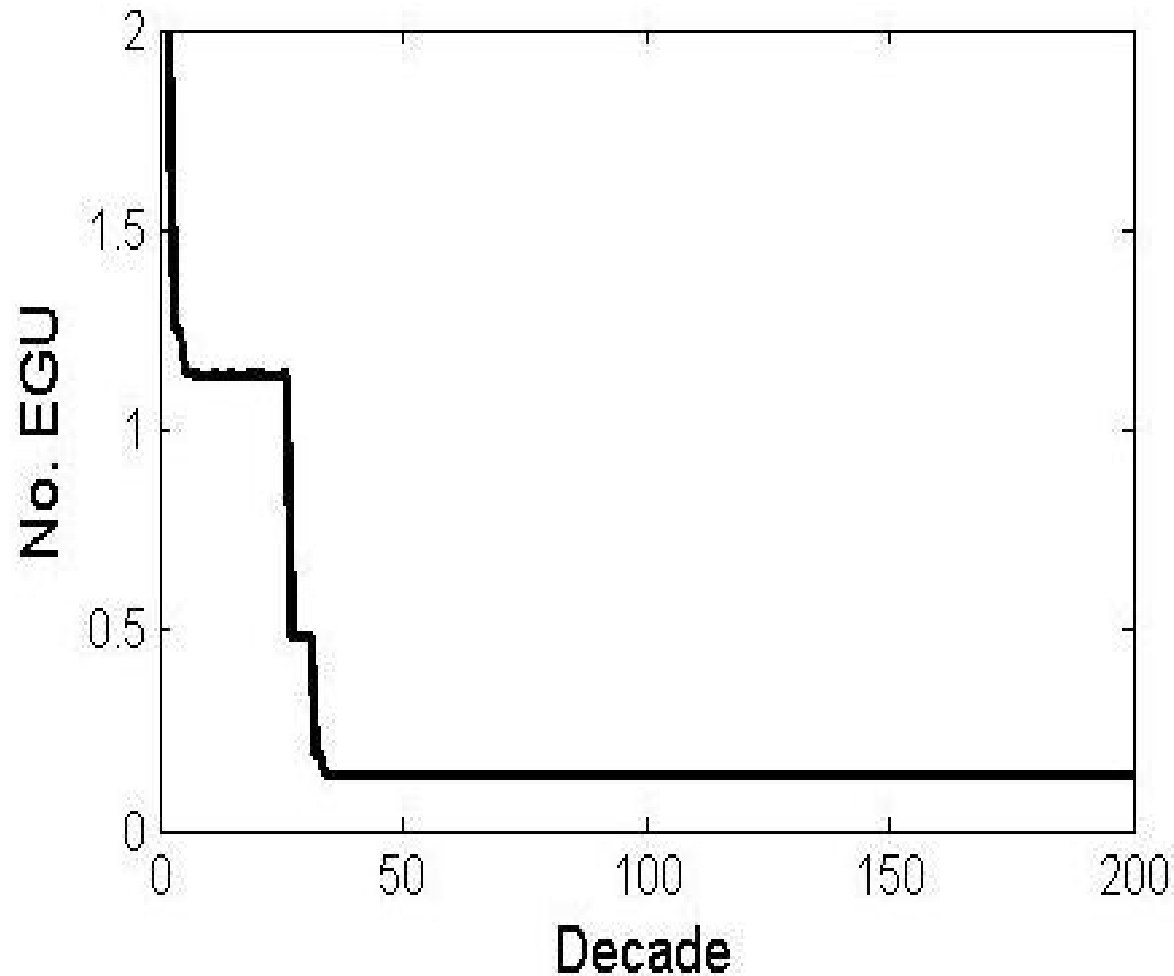

Figure 9. Convergence process of the objective function.

Table 3. Comparison of the preliminary design and ICA results for minimum number of entropy generation units.

Configuration	Parameter	Preliminary design	ICA
Basic design parameters	Heat transfer area (AHT) (m <sup>2</sup> )	142.7552	455.88
	Volume (m <sup>3</sup> )	0.0902	0.7596
	Heat duty, Q (kW)	1069.8	1069.8
Optimal design variables	Hot flow length (La) (m)	0.3	1
	Cold flow length (Lb) (m)	0.3	0.88
	Fin height (H) (mm)	2.49	5
	Fin thickness (t) (mm)	0.10	0.19
	Fin frequency (n) (m <sup>-1</sup> )	782	240
	Fin offset length (lfa) (mm)	3.18	9.6
	Number of hot side layers (N <sub>a</sub> )	167	77
Constrained conditions	$\Delta P_a$ at hot side (kPa)	9.34	1.23
	$\Delta P_b$ at cold side (kPa)	6.90	0.67
	No-flow length, L <sub>c</sub> (m)	1	0.87
Objective	Number of entropy generation units	0.1576	0.1374

**Table 4.** Comparison of results from ICA and GA methods.

Parameter	ICA	GA
Objective function	0.1374	0.1416
Convergence iterations	40	30
Hot flow length (La) (m)	1	0.95
Cold flow length (Lb) (m)	0.88	0.44
Fin height (H) (mm)	5	7.2
Fin thickness (t) (mm)	0.19	0.1
Fin frequency (n) (m <sup>-1</sup> )	240	417
Fin offset length (lfa) (mm)	9.6	7.2
Number of hot side layers (N <sub>a</sub> )	77	57
$\Delta P_a$ at hot side (kPa)	1.23	4.2
$\Delta P_b$ at cold side (kPa)	0.67	0.52
No-flow length, L <sub>c</sub> (m)	0.87	0.87

to the work of Sanaye and Hajabdollahi (2010) while the population size and number of generations are set to 100 and 200 respectively.

It can be seen that ICA provides better results while GA converge in less iterations. The GA yields to 0.1416 which is higher than the results of ICA. It is very interesting to see that the configuration result by two methods are very different although the objective function which has been achieved is just slightly different. The fin height and fin frequency in the GA method are higher than ICA while hot flow length, cold flow length and fin thickness are smaller.

## Conclusions

In this paper a relatively new evolutionary algorithm based on social-political evolution of societies is used for the first time to optimize the geometry configuration of plate fin heat exchangers. This also is considered the first application of the ICA in entire thermal engineering problems. The primary objective of the optimization algorithm is the minimization of the total number of entropy generation units. The  $\epsilon - NTU$  method is used for the PFHE thermal calculations. A case study from the literature is selected for examination of the performance and accuracy of this new method. The main findings of this study are as follows:

- 1) The findings demonstrate that the results attained from the ICA are better than the preliminary design considering the respected objective function.
- 2) The ICA algorithm compared to the traditional GA shows improvements in the optimum designs under the same population size and iterations.

The design procedure for the PFHEs presented in this

study by using the ICA can be applied to the other types of heat exchanger such as fin-and-tube heat exchangers, sell-and-tube heat exchangers and recuperators as well. Moreover, other types of fins such as plain, perforated, wavy and louvered fins can be applied on both cold and hot sides of the heat exchanger rather than the serrated fins which is applied on the both side in the present work. Therefore, ICA can be applied in design of different types of heat exchangers to search for the optimum designs based on the desired objectives.

## REFERENCES

- Atashpaz-Gargari E, Lucas C (2007). Imperialist competitive algorithm: An algorithm for optimization inspired by imperialistic competition. In Evolutionary Computation, CEC IEEE Congress.
- Bejan A (1977). The Concept of Irreversibility in Heat Exchanger Design: Counterflow Heat Exchangers for Gas-to-Gas Applications. *J. Heat Transf.*, 99(3): 374-380.
- Incropera FP, DeWitt DP (2010). *Fundamentals of Heat and Mass Transfer*: John Wiley & Sons Inc.
- Iyengar M, Bar-Cohen A (2003). Least-energy optimization of forced convection plate-fin heat sinks. *IEEE Trans. Compon. Packaging Technol.*, 26(1): 62-70.
- London AL, (1982). Economics and the second law: An engineering view and methodology. *Int. J. Heat Mass Transf.*, 25(6): 743-751.
- Lucas C, Nasiri-Gheidari Z, Tootoonchian F (2010). Application of an imperialist competitive algorithm to the design of a linear induction motor. *Energy Convers. Manage.*, 51(7): 1407-1411.
- Manglik RM, Bergles AE (1995). Heat transfer and pressure drop correlations for the rectangular offset strip fin compact heat exchanger. *Exp. Therm. Fluid Sci.*, 10(2): 171-180.
- Mishra M, Das PK, Sarangi S (2004). Optimum design of crossflow plate-fin heat exchangers through genetic algorithm. *Int. J. Heat Exchangers*, 5(2): 379-401.
- Najafi H, Najafi B (2010). Multi-objective optimization of a plate and frame heat exchanger via genetic algorithm. *Heat Mass Transf.*, 46(6): 639-647.
- Nazari-Shirkouhi S, Eivazy H, Ghodsi R, Rezaie K, Atashpaz-Gargari E (2010). Solving the integrated product mix-outsourcing problem using the Imperialist Competitive Algorithm. *Expert Syst. Appl.*, 37(12): 7615-7626.
- Niknam T, Babak A, Alireza R (2011). An efficient hybrid algorithm based on modified imperialist competitive algorithm and K-means for data clustering. *Eng Appl. Artif. Intell.*, 24(2): 306-317.
- Ogulata RT, Doba F (1998). Experiments and entropy generation minimization analysis of a cross-flow heat exchanger. *Int. J. Heat Mass Transf.*, 41(2): 373-381.
- Ozkol I, Komurgoz G (2005). Determination of the optimum geometry of the heat exchanger body via a genetic algorithm. *Numer. Heat Transf.; Part A: Appl.*, 48(3): 283-296.
- Pacheco-Vega A, Sen M, Yang KT (2003). Simultaneous determination of in- and over-tube heat transfer correlations in heat exchangers by global regression. *Int. J. Heat Mass Transf.*, 46(6): 1029-1040.
- Pacheco-Vega A, Sen M, Yang KT, McClain RL (1998). Genetic algorithms-based predictions of fin-tube heat exchanger performance in 11th International Heat Transfer Conference. Kyongju, Korea.
- Peng H, Ling X (2008). Optimal design approach for the plate-fin heat exchangers using neural networks cooperated with genetic algorithms. *Appl. Therm. Eng.*, 28(5-6): 642-650.
- Peng H, Ling X, Wu E (2010). An Improved Particle Swarm Algorithm for Optimal Design of Plate-Fin Heat Exchangers. *Ind. Eng. Chem. Res.*, 49(13): 6144-6149.
- Rao RV, Patel VK (2010). Thermodynamic optimization of cross flow plate-fin heat exchanger using a particle swarm optimization algorithm. *Int. J. Therm. Sci.*, 49(9): 1712-1721.
- Sanaye S, Hajabdollahi H (2010). Thermal-economic multi-objective optimization of plate fin heat exchanger using genetic algorithm. *Appl. Energy*, 87(6): 1893-1902.

- Selbas R, Kizilkan Ö, Reppich M (2006). A new design approach for shell-and-tube heat exchangers using genetic algorithms from economic point of view. *Chem. Eng. Process.*, 45(4): 268-275.
- Shah RK, Sekulić DP (2003). *Fundamentals of Heat Exchanger Design*: John Wiley & Sons, Inc.
- Tayal MC, Fu Y, Diwekar UM (1999). Optimal design of heat exchangers: A genetic algorithm framework. *Ind. Eng. Chem. Res.*, 38(2): 456-467.
- Vargas JVC, Bejan A (2001). Thermodynamic optimization of finned crossflow heat exchangers for aircraft environmental control systems. *Int. J. Heat Fluid Flow*, 22(6): 657-665.
- Xie GN, Sunden B, Wang QW (2008). Optimization of compact heat exchangers by a genetic algorithm. *Appl. Therm. Eng.*, 28(8-9): 895-906.