

*Review Paper*

# Investigation of cutting parameters of surface roughness for a non-ferrous material using artificial neural network in CNC turning

C. Natarajan, S. Muthu and P. Karuppuswamy

Department of Mechanical Engineering, Sri Ramakrishna Engineering College, Coimbatore-641022, Tamilnadu, India.

Accepted 22 November, 2010

**Surface roughness, an indicator of surface quality is one of the most specified customer requirements in a machining process. For efficient use of machine tools, optimum cutting parameters (speed, feed and depth of cut) are required. So it is necessary to find a suitable optimization method which can find optimum values of cutting parameters for minimizing surface roughness. The turning process parameter optimization is highly constrained and nonlinear. In this work, machining process was carried out on brass C26000 material in dry cutting condition in a CNC turning machine and surface roughness was measured using Surface Roughness Tester. To predict the surface roughness, an artificial neural network (ANN) model was designed through back propagation network using Matlab 7 software for the data obtained. Comparison of the experimental data and ANN results show that there is no significant difference and ANN was used confidently. The results obtained, conclude that ANN is reliable and accurate for solving the cutting parameter optimization.**

**Key words:** CNC turning process, non-ferrous material, surface roughness, artificial neural network (ANN), optimization.

## INTRODUCTION

Now-a-days, due to the increasing demand of higher precision components for its functional aspect, surface roughness of a machined part plays an important role in the modern manufacturing process. Turning is a machining operation, which is carried out on lathe. The quality of the surface plays a very important role in the performance of turning as a good quality turned surface significantly improves fatigue strength, corrosion resistance, or creep life. Surface roughness also affects several functional attributes of parts, such as, contact causing surface friction, wearing, light reflection, heat transmission, ability of distributing and holding a lubricant, load bearing capacity, coating or resisting fatigue. Therefore, the desired finish surface is usually specified and the appropriate processes are selected to

reach the required quality (Mike et al., 1998). To achieve the desired surface finish, a good predictive model is required for stable machining. Generally, these models have a complex relationship between surface roughness and operational parameters, work materials and chip breaker types.

Artificial neural networks (ANNs) are information processing systems, and since their inception, they have been used in several areas of engineering applications. In experimental studies, some of the operating conditions of a system can be investigated. For this type of experimental work, experts and special equipment are needed. It also requires too much time and high cost. ANNs have been trained to solve non-linear and complex problems that are not exactly modelled mathematically. ANNs eliminate the limitations of the classical approaches by extracting the desired information using the input data. Applying ANN to a system needs sufficient input and output data instead of a mathematical equation. Furthermore, it can continuously re-train for new data

\*Corresponding author. E-mail: [cnat666@gmail.com](mailto:cnat666@gmail.com). Tel: 0422-2460088. Fax: 0422-2461089.

during the operation, thus it can adapt to changes in the system. ANNs can also be used to deal with problems with incomplete and imprecise data.

In this work, artificial neural network model have been developed to predict the surface roughness on the machining of brass C26000 metal. To judge the efficiency and ability of the model to predict surface roughness values, percentage deviation and average percentage deviation are used. The results obtained, conclude that ANN is reliable and accurate for predicting the values. The actual  $R_a$  value was obtained as  $1.1999 \mu\text{m}$  and the corresponding predicted surface roughness value was  $1.1859 \mu\text{m}$ , which implies greater accuracy.

### Literature survey

Since turning is the primary operation in most of the production processes in the industry, surface finish of turned components has greater influence on the quality of the product. Surface finish in turning had been found to be influenced in varying amounts by a number of factors such as feed rate, work material characteristics, work hardness, unstable built-up edge, cutting speed, depth of cut, cutting time, tool nose radius. According to these parameters, a detailed literature survey is carried out as follows. David et al. (2006) described an approach to predict Surface roughness in a high speed end-milling process and used artificial neural networks (ANN) and statistical tools to develop different surface roughness predictors. Srikanth and Kamala (2008) proposed a real coded genetic algorithm (RCGA) to find optimum cutting parameters and explained various issues of RCGA and its advantages over the existing approach of binary coded genetic algorithm (BCGA). Franic and Joze (2003) used binary coded genetic algorithm (BCGA) for the optimization of cutting parameters. This genetic algorithm optimizes the cutting conditions having an influence on production cost, time and quality of the final product. Suresh et al. (2002) developed optimum surface roughness predictive model using binary coded genetic algorithm (BCGA). This GA program gives minimum and maximum values of surface roughness and their respective optimal machining conditions. Yang and Tarn (1998) used Taguchi method for design optimization on surface quality. An orthogonal array, the signal-to-noise (S/N) ratio and the analysis of variance (ANOVA) were employed to investigate the cutting characteristics. Uros and Franci (2003) proposed a neural network-based approach to complex optimization of cutting parameters and described the multi-objective technique of optimization of cutting conditions by means of the neural networks taking into consideration the technological, economic and organizational limitations. Oktem et al. (2005) utilized response surface methodology to create an efficient analytical model for surface roughness in terms of cutting parameters: Feed, cutting speed, axial

depth of cut, radial depth of cut and machining tolerance. Al-Ahmari (2007) developed empirical models for tool life, surface roughness and cutting force for turning operations. Two important data mining techniques used were response surface methodology and neural networks. Huang and Joseph (2001) predicted in-process surface roughness through multiple regression model in turning operation via accelerometer. Hossain et al. (2008) developed an artificial neural network algorithm for predicting the surface roughness in end milling of Inconel 718 alloy. Avisekh et al. (2009) conducted a study of feasibility of on-line monitoring of surface roughness in turning operations using a developed opto-electrical transducer. Regression and neural network (NN) models were exploited to predict surface roughness and compared to actual and on-line measurements. Groover and Mikell (1996) depicted the impact of three factors, namely, the feed, nose radius, and cutting-edge angles, on surface roughness. Azouzi and Guillot (1997) proposed an on-line prediction of surface finish and dimensional deviation in turning using neural network based sensor fusion. Feng and Hu (2001) addressed a comparative study of the ideal and actual surface roughness in finish turning and also applied the fractional factorial experimentation approach for studying the impact of turning parameters on the roughness of turned surfaces and used analysis of variances to examine the impact of turning factors and factor interactions on surface roughness. Muammer et al. (2007) addressed regression analysis and neural network-based models used for the prediction of surface roughness and compared for various cutting conditions in turning. Bajic et al. (2008) focused on modeling of machined surface roughness and optimization of cutting parameters in face milling and examined the influence of cutting parameters on surface roughness in face milling. Sakir et al. (2008) worked on the prediction of surface roughness using artificial neural network in lathe and investigated the effect of tool geometry on surface roughness in universal lathe and carried out machining process on AISI 1040 steel in dry cutting condition using various insert geometry at depth of cut of 0.5 mm.

Optimization of machining parameters not only increases the utility for machining economics, but also the product quality to a great extent. The dynamic nature and widespread usage of turning operations in practice have raised a need for seeking a systematic approach that can help to set-up turning operations in a timely manner and also to achieve the desired surface roughness quality.

After a detailed literature survey, it is inferred that there are no appropriate surface recognition models for machining Brass C26000 metal in CNC turning. The experimental works were conducted in a leading pump manufacturing company. The seamless pipe which is being manufactured in the pump industry made up of Brass C26000 requires more surface finish in the inner

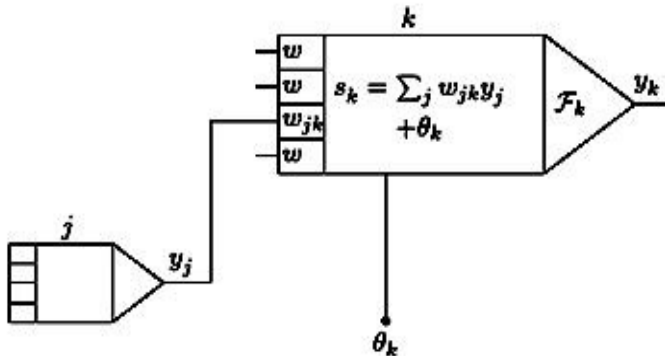

Figure 1. Basic components of an artificial neural network.

surface area that is considered in this work.

This work predicts the surface recognition system based on artificial neural network (ANN) technique over Brass C26000 metal in CNC turning

## PROBLEM DEFINITION

Most of the measurement techniques have limitations to their in-process use. The purpose of the analysis is to develop techniques to predict the surface roughness of a part to be machined and to avoid “trial and error” approaches to set-up turning conditions in order to achieve the desired surface roughness. The goal of which is to predict surface roughness ( $R_a$ ) under multiple cutting conditions determined by spindle speed, feed rate and depth of cut. Surface roughness would be measured directly by surface roughness measuring instruments. Experimental results are expected to show that parameters of spindle speed, feed rate and depth of cut could predict surface roughness ( $R_a$ ) under different combinations of cutting parameters.

## Artificial neural networks

The artificial neural network which is described in this work is all variations on the parallel distributed processing (PDP) idea. The architecture of each network is based on very similar building blocks which perform the processing.

## A framework for distributed representation

An artificial network consists of a pool of simple processing units which communicate by sending signals to each other over a large number of weighted connections. A set of major aspects of a parallel distributed model can be distinguished:

1. A set of processing units ('neurons,' 'cells');

2. A state of activation  $y_k$  for every unit, which equivalent to the output of the unit;
3. Connections between the units. Generally each connection is defined by a weight  $w_{jk}$  which determines the effect which the signal of unit  $j$  has on unit  $k$ ;
4. A propagation rule, which determines the effective input  $s_k$  of a unit from its external inputs;
5. An activation function  $F_k$ , which determines the new level of activation based on the effective input  $s_k(t)$  and the current activation  $y_k(t)$  (that is, the update);
6. An external input (aka bias, offset)  $\theta_k$  for each unit;
7. A method for information gathering (the learning rule);

An environment within which the system must operate, providing input signals and if necessary- error signals. Figure 1 illustrates the aforementioned basics; the propagation rule used here is the 'standard' weighted summation.

## Processing units

Each unit performs a relatively simple job: Receive input from neighbors or external sources and use this to compute an output signal which is propagated to other units. Apart from this processing, a second task is the adjustment of the weights. The system is inherently parallel in the sense that many units can carry out their computations at the same time.

Within neural systems, it is useful to distinguish three types of units: Input units (indicated by an index  $i$ ) which receive data from outside the neural network; output units (indicated by an index  $o$ ) which send data out of the neural network, and hidden units (indicated by an index  $h$ ) whose input and output signals remain within the neural network.

## Connections between units

In most cases, it is assumed that each unit provides an additive contribution to the input of the unit with which it is connected. The total input to unit  $k$  is simply the weighted sum of the separate outputs from each of the connected units plus a bias or offset term  $\theta_k$ ,

$$s_k(t) = \sum_j w_{jk}(t) y_j(t) + \theta_k(t) \quad (1)$$

The contribution for positive  $w_{jk}$  is considered as an excitation and for negative  $w_{jk}$  as inhibition. In some cases, more complex rules for combining inputs are used, in which a distinction is made between excitatory and inhibitory inputs. We call units with propagation rule (1) sigma units.

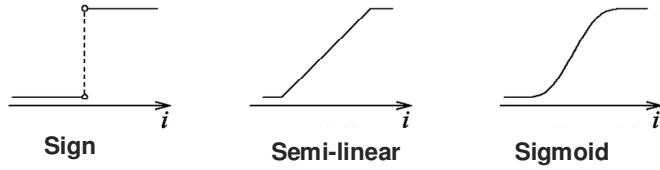

Figure 2. Activation function.

A different propagation rule, introduced by Feldman and Ballard, is known as the propagation rule for the sigma-pi unit,

$$s_k(t) = \sum_j w_{jk}(t) \prod_m y_{jm}(t) + \theta_k(t) \quad (2)$$

Often, the  $y_{jm}$  are weighted before multiplication. Although these units are not frequently used, they have their value for gating of input, as well as implementation of lookup tables.

### Activation and output rules

It also needed a rule which gives the effect of the total input on the activation of the unit. We need a function  $F_k$  which takes the total input  $s_k(t)$  and the current activation  $y_k(t)$  and produces a new value of the activation of the unit  $k$ :

$$y_k(t+1) = \mathcal{F}_k(y_k(t), s_k(t)) \quad (3)$$

Often, the activation function is a non-decreasing function of the total input of the unit, although activation functions are not restricted to non-decreasing functions. Generally, some sort of threshold function is used: A hard limiting threshold function (a SGN function), or a linear or semi-linear function, or a smoothly limiting threshold (Figure 2):

$$y_k(t+1) = \mathcal{F}_k(s_k(t)) = \mathcal{F}_k\left(\sum_j w_{jk}(t) y_j(t) + \theta_k(t)\right) \quad (4)$$

For this smoothly limiting function often a sigmoid (S-shaped) function like (5) is used. In some applications, a hyperbolic tangent is used, yielding output values in the range [-1 to +1]:

$$y_k = \mathcal{F}(s_k) = \frac{1}{1 + e^{-s_k}} \quad (5)$$

In some cases, the output of a unit can be a stochastic function of the total input of the unit. In that case, the activation is not deterministically determined by the neuron input, but the neuron input determines the probability  $p$  that a neuron gets a high activation value, in which  $T$  (temperature) is a parameter which determines the slope of the probability function:

$$p(y_k \rightarrow 1) = \frac{1}{1 + e^{-s_k/T}}, \quad (6)$$

### Network topologies

Here, the pattern of connections between the units and the propagation of data was focused on. As for this pattern of connections, the main distinction we can make is between:

1. Feed-forward networks, where the data flow from input to output units is strictly feed forward. The data processing can extend over multiple (layers of) units, but no feedback connections are present, that is, connections extending from outputs of units to inputs of units in the same layer or previous layers.
2. Recurrent networks that do contain feedback connections. Contrary to feed-forward networks, the dynamical properties of the network are important. In some cases, the activation values of the units undergo a relaxation process such that the network will evolve to a stable state in which these activations do not change anymore. In other applications, the changes in the activation values of the output neurons are significant, such that the dynamical behaviour constitutes the output of the network.

### DEVELOPMENT OF A NEURAL NETWORK MODEL

The network used in the program is a feed forward network with back propagation learning rule. Training begins with all weights set to random numbers. For each data record, the predicted value is compared to the desired (actual) value and the weights are adjusted to move the prediction closer to the desired value. Many cycles are made through the entire set of training data with the weights being continually adjusted to produce more accurate predictions.

### Architecture of the proposed artificial neural network

The artificial neural network architecture developed by hit and trial method has one input layer, one output layer and two hidden layers with 4, 3, 3, 1 neurons in the layers respectively. The ranges of the inputs for the four layers are specified. Figure 3 shows overview of the network.

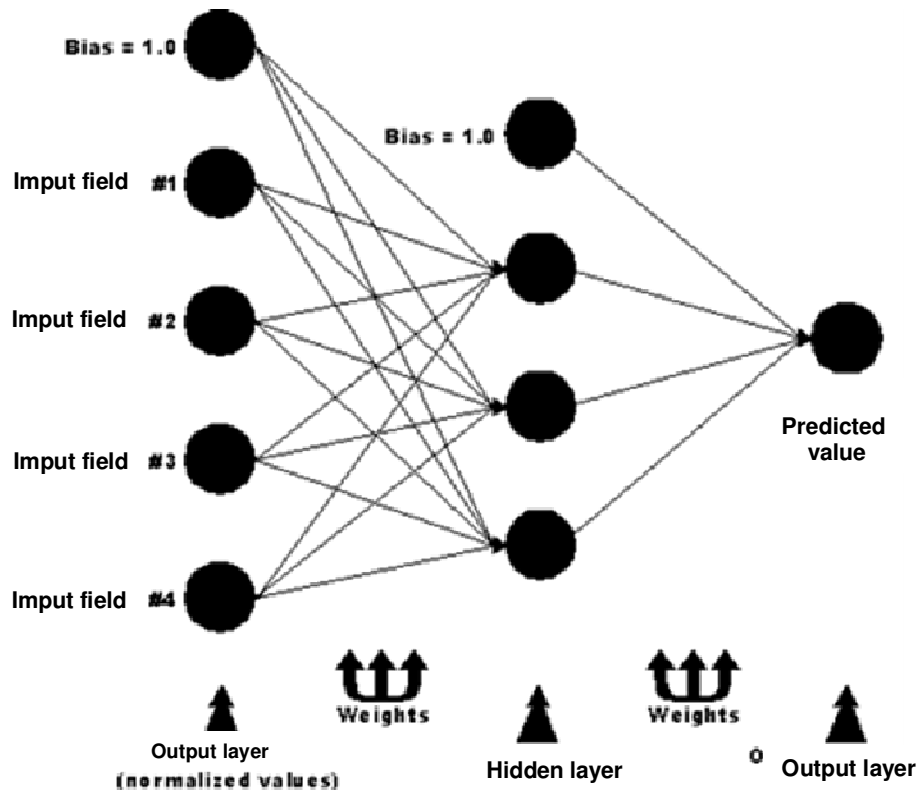

Figure 3. Typical back propagation network.

The activation function for the input and the two hidden layers is chosen as tansigmoidal function. The activation function for the output layer is chosen as purelinear function.

The network is then simulated for the input values and a graph is plotted between the output and target (neural network output) values. The network created is trained for the input and output values. The stopping criterion for training is number of epochs and is given as 300. The network is again simulated for the input values and a graph is plotted between the output and target (neural network output) values. The deviations are noted from the graphical output of the program. The input values for the test readings are then given and the network is trained. The target value is then obtained and compared with actual output. The network has an input layer, two hidden layers and an output layer (Figure 4).

### Input layer

The input layer has four neurons (Figure 5).

### First hidden layer

First hidden layer has three neurons (Figure 6).

### Second hidden layer

Second hidden layer has three neurons (Figure 7).

### Output layer

The output layer has a single neuron (Figure 8).

### Execution of experiments

The tests were performed on a CNC turning center. The brass C26000 metal work piece with dimensions of diameter 20 mm and length of 85 mm was clamped onto to the turret of the machine table. Surface roughness measurement was done off line with the usage of TIME TR100 surface roughness tester. The radius of the stylus point is  $10.0 \pm 2.5$  micron and the traversed length is 6 mm.

The experimental setup consists of a CNC machine, battery unit for back up purpose, power supply and the whole setup is connected to the computer interface. A computer numeric control (CNC) program was written to perform the turning process. The parameters defined in the CNC machine were: Spindle speed ( $x_1$ ), feed rate ( $x_2$ ), depth of cut ( $x_3$ ). According to the acceptable ranges

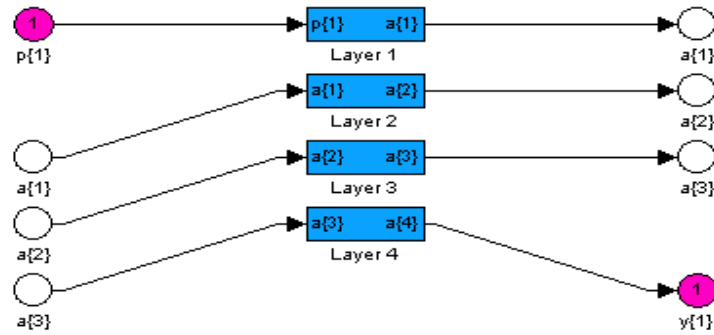

Figure 4. Overview of the network.

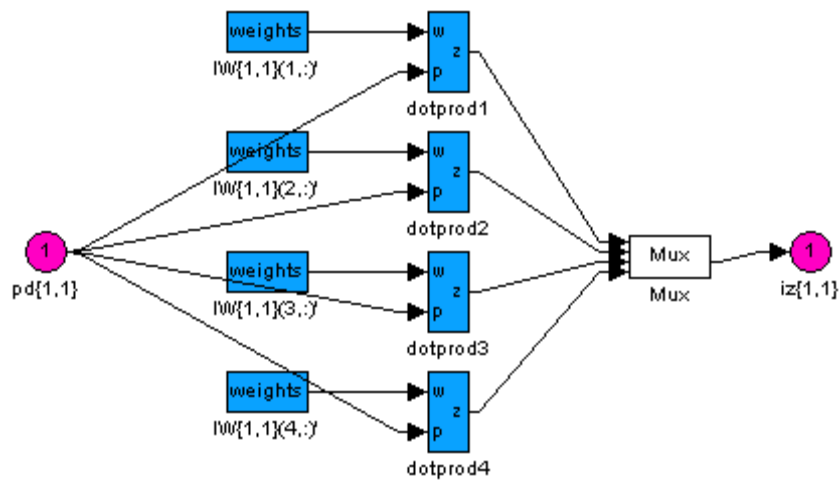

Figure 5. Input layer.

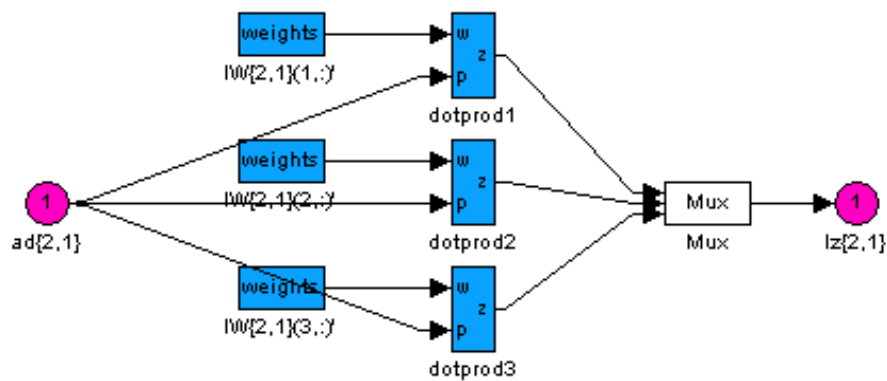

Figure 6. First hidden layer.

of spindle speed and feed rate when cutting brass with a CNMG 120408 insert with a tool holder PCLNR120408 and nose radius of 0.8, a series of procedures were used to determine the cutting parameters, such as spindle

speed, feed rate, and depth of cut and then an NC program is written to execute the cutting operations. Three levels of each factor were selected. Following are the cutting parameters used in the experiment: spindle

**Table 1.** Experimental readings and actual roughness.

S. No	Spindle Speed (rpm)	Feed rate (mm/rev)	Depth of cut (mm)	Roughness				Roughness ( $\mu\text{m}$ )
				Trial1	Trial2	Trial3	Average	
<b>Training set</b>								
1	2500	0.05	0.2	0.95	0.93	0.92	0.9333	0.7933
2	2500	0.05	0.3	1.01	0.96	0.98	0.9833	0.8433
3	2500	0.05	0.4	1.07	1.08	1.11	1.0867	0.9467
4	2500	0.12	0.2	1.44	1.47	1.49	1.4667	1.3267
5	2500	0.12	0.3	1.33	1.3	1.28	1.3033	1.1633
6	2500	0.12	0.4	1.56	1.59	1.61	1.5867	1.4467
7	2500	0.15	0.2	1.13	1.1	1.07	1.1000	0.9600
8	2500	0.15	0.3	1.17	1.14	1.12	1.1433	1.0033
9	2500	0.15	0.4	1.12	1.09	1.13	1.1133	0.9733
10	3250	0.05	0.2	0.94	0.95	0.96	0.9500	0.8100
11	3250	0.05	0.3	1.01	1.05	1.07	1.0433	0.9033
12	3250	0.05	0.4	1.14	1.15	1.12	1.1367	0.9967
13	3250	0.12	0.2	1.13	1.08	1.09	1.1000	0.9600
14	3250	0.12	0.3	1.36	1.38	1.4	1.3800	1.2400
15	3250	0.12	0.4	1.62	1.63	1.63	1.6267	1.4867
16	3250	0.15	0.2	1.1	1.08	1.13	1.1033	0.9633
17	3250	0.15	0.3	1.24	1.26	1.21	1.2367	1.0967
18	3250	0.15	0.4	1.33	1.29	1.29	1.3033	1.1633
19	3500	0.05	0.2	1.06	1.08	1.1	1.0800	0.9400
20	3500	0.05	0.3	1.11	1.07	1.1	1.0933	0.9533
21	3500	0.05	0.4	1.23	1.25	1.27	1.2500	1.1100
22	3500	0.12	0.2	0.94	0.95	0.93	0.9400	0.8000
23	3500	0.12	0.3	1.37	1.35	1.39	1.3700	1.2300
24	3500	0.12	0.4	1.24	1.24	1.21	1.2300	1.0900
25	3500	0.15	0.2	1.16	1.14	1.15	1.1500	1.0100
26	3500	0.15	0.3	1.21	1.18	1.21	1.2000	1.0600
27	3500	0.15	0.4	1.19	1.19	1.18	1.1867	1.0467
<b>Test readings</b>								
28	2750	0.08	0.15	1.21	1.19	1.23	1.2100	1.0700
29	2750	0.08	0.25	1.2	1.21	1.21	1.2067	1.0667
30	2750	0.08	0.35	1.2	1.18	1.2	1.1933	1.0533
31	3000	0.1	0.15	1.44	1.43	1.4	1.4233	1.2833
32	3000	0.1	0.25	1.55	1.55	1.55	1.5500	1.4100
33	3000	0.1	0.35	1.21	1.19	1.19	1.1967	1.0567
34	3300	0.13	0.15	1.57	1.58	1.6	1.5833	1.4433
35	3300	0.13	0.25	1.24	1.27	1.28	1.2633	1.1233
36	3300	0.13	0.35	1.44	1.42	1.44	1.4333	1.2933

speed (2500, 3250, 3500 rpm), feed rate (0.05, 0.12 and 0.15 mm/rev) and depth of cut (0.2, 0.3, 0.4 mm). Thus, there were totally 36 specimens in this experiment.

All specimens in this experiment were machined under dry cutting conditions. Coolants are generally avoided to reduce costs and prevent tool breakage due to thermal shock. The tool was checked time to time to make sure that it was still functioning properly. Also, after every

specimen was cut, the cutting tool was cleaned to avoid chip formation or a built-up edge (BUE) which might affect the surface roughness of the following specimens. In addition, the following assumptions were made: (1) The cutting tools used are identical in property; (2) The hardness of each work piece is same throughout the length of the work piece; (3) Surface roughness values are not affected by abnormal factors; (4) Surface

**Table 2.** Percentage deviations between actual roughness values and predicted roughness values.

Sample number	Spindle speed (rpm)	Feed rate (mm/rev)	Depth of cut (mm)	Roughness average	Normalised	Actual roughness ( $\mu\text{m}$ )	Matlab readings ( $\mu\text{m}$ )	Difference	Percentage deviation
28	2750	0.08	0.15	1.2100	0.785714286	1.0700	1.0004	0.0696	6.504673
29	2750	0.08	0.25	1.2067	0.785714286	1.0667	1.3283	0.261633	24.52813
30	2750	0.08	0.35	1.1933	0.785714286	1.0533	1.4056	0.352267	33.44304
31	3000	0.1	0.15	1.4233	0.857142857	1.2833	0.8909	0.392433	30.57922
32	3000	0.1	0.25	1.5500	0.857142857	1.4100	1.3305	0.0795	5.638298
33	3000	0.1	0.35	1.1967	0.857142857	1.0567	1.5215	0.464833	43.99054
34	3300	0.13	0.15	1.5833	0.942857143	1.4433	0.8526	0.590733	40.92841
35	3300	0.13	0.25	1.2633	0.942857143	1.1233	1.2937	0.170367	15.16617
36	3300	0.13	0.35	1.4333	0.942857143	1.2933	1.0494	0.243933	18.86082
Average									24.40437

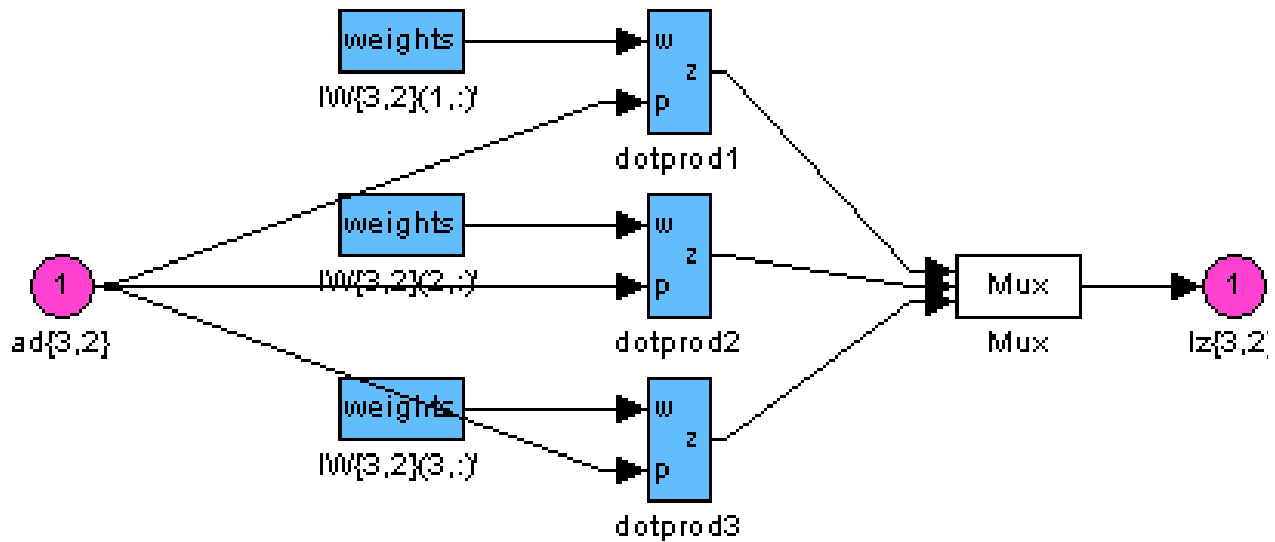

**Figure 7.** Second hidden layer.

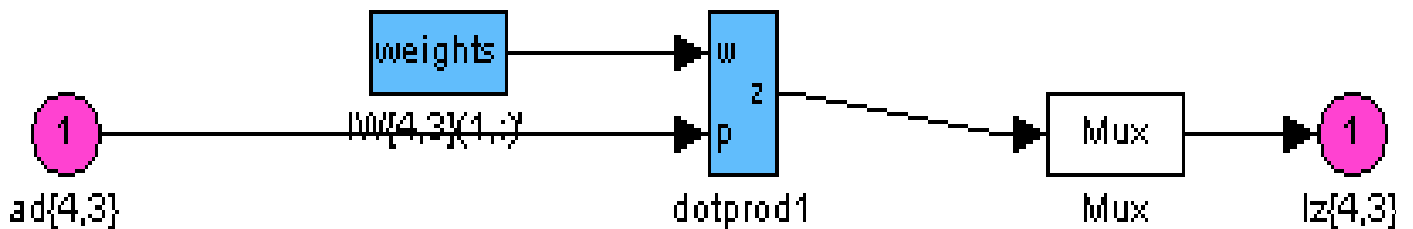

**Figure 8.** Output layer.

roughness values measured within the measuring area are sufficient to represent the roughness of entire work

piece; (5) The effect of approach angle is not considered; (6) Vibration is negligible, and (7) Tool nose radius is



constant.

## RESULTS AND DISCUSSION

The actual roughness values have been calculated for each set of readings and the same are compared with predicted roughness values obtained by using Matlab 7 software. The percentage deviation between actual roughness values and predicted roughness values have been calculated and tabulated which is shown in Table 2. Average percentage deviation is 24.4%.

### Comparison of graphical results

Figure 9 shows comparison between actual and predicted roughness values and some of the specimens only deviating from the actual roughness values.

Figure 10 shows plot between relative piece numbering and percentage deviation between actual and predicted surface roughness. The percentage of deviation is about 24.4%.

Figure 11 shows the interaction plot between speed and surface roughness at constant depth of cut of 0.2 mm. Feed values are taken as 0.05, 0.12 and 0.15 mm/rev and this plot obviously predicts that surface roughness value decreases with increase in speed and feed for smaller depth of cut.

Figure 12 shows the interaction plot between speed and surface roughness at constant depth of cut of 0.3 mm. Feed values are taken as 0.05, 0.12 and 0.15 mm/rev and in this plot, roughness values are not affected more while increasing speed and feed.

Figure 13 shows the interaction plot between speed and surface roughness at constant depth of cut of 0.4 mm. Feed values are taken as 0.05, 0.12 and 0.15 mm/rev and this plot clearly predicts that surface roughness value increases up to certain level and decreases with increase in speed and feed for larger depth of cut.

Figure 14 shows the interaction plot between depth of cut and surface roughness at constant feed of 0.05 mm/rev. Speed values are set as 2500, 3250 and 3500 rpm and this plot clearly predicts that surface roughness value is increased considerably with increase in speed and depth of cut for smaller feed rate.

Figure 15 shows the interaction plot between depth of cut and surface roughness at constant feed of 0.12 mm/rev. Speed values are set as 2500, 3250 and 3500 rpm and this plot expresses that surface roughness value is increased to certain level and decreased predominantly for higher speed and the surface roughness value is decreased to certain level and decreased obviously for lower speed with comparatively increase in feed rate.

Figure 16 shows the interaction plot between depth of cut and surface roughness at constant feed of 0.15

mm/rev. Speed values are set as 2500, 3250 and 3500 rpm and this plot depicts that roughness value is affected with increase in depth of cut and increase in speed also while increasing feed comparatively.

Figure 17 shows the interaction plot between feed rate and surface roughness at constant Speed of 2500 rpm. Depth of cut values are set as 0.2, 0.3, and 0.4 mm and this plot obviously predicts that surface roughness value is increased to certain level and decreased considerably for increasing feed rate and decreasing depth of cut for comparatively smaller spindle speed.

Figure 18 shows the interaction plot between feed rate and surface roughness at constant speed of 3250 rpm. Depth of cut values are set as 0.2, 0.3 and 0.4 mm and this plot absolutely expresses that surface roughness value is increased to certain level and decreased considerably with increase in feed and depth of cut and also increase in speed comparatively.

Figure 19 shows the interaction plot between feed rate and surface roughness at constant speed of 3500 rpm. Depth of cut values are set as 0.2, 0.3 and 0.4 mm and this plot obviously depicts that surface roughness value is decreased considerably to a certain level and increased for smaller depth of cut and increased feed at comparatively higher speed. And the surface roughness value is increased considerably to a certain level and decreased with increase in feed rate and higher depth of cut at comparatively higher speed.

### Conclusion

In this work, 36 specimens which are made up of the brass C26000 material have been machined in a CNC turning machine and then a TIME TR 100 surface roughness tester had been used to measure the roughness average ( $R_a$ ) values of all the specimens. The surface recognition model had been developed through artificial neural networks technique. This type of model had been evaluated by means of the percentage deviation between the predicted  $R_a$  values and the actual  $R_a$  values. The important conclusions drawn from the present research are summarized as follows:

1. The surface roughness could be effectively predicted by using spindle speed, feed rate, and depth of cut as the input variables.
2. Considering the individual parameters, feed rate had been found to be the most influencing parameter, followed by spindle speed and depth of cut.
3. Model (including interaction terms), considering the interaction between the individual parameters, could achieve an accuracy of 75.6%.
4. The average actual roughness  $R_a$  value had been obtained as 1.1999  $\mu\text{m}$  and the corresponding predicted surface roughness value is 1.1859  $\mu\text{m}$ .
5. As the spindle speed increases for lower feed rates, the surface roughness decreases. For higher feed rates,

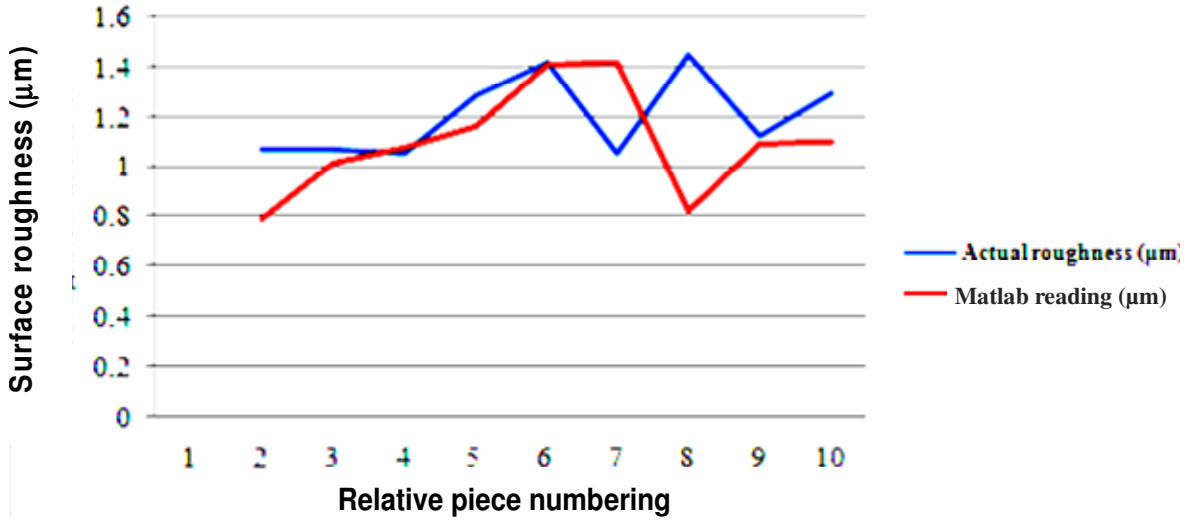

Figure 9. Comparison of actual and predicted roughness values.

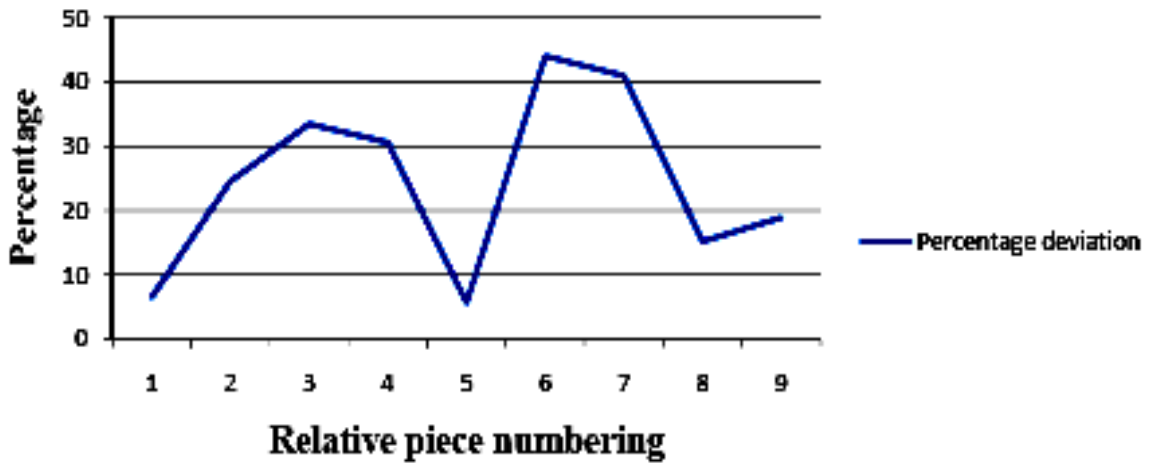

Figure 10. Percentage deviation between actual and predicted roughness values.

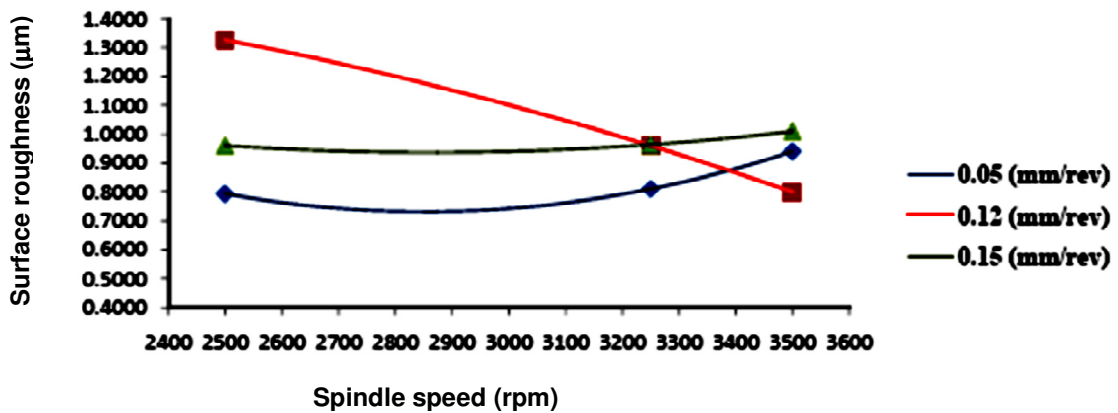

Figure 11. Spindle speed vs surface roughness at DOC = 0.2 mm.

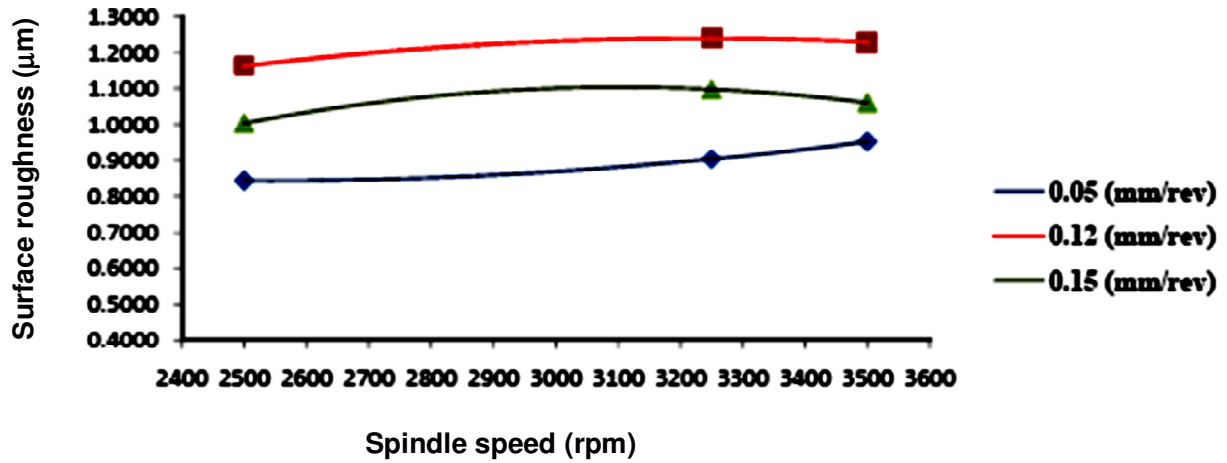

Figure 12. Spindle speed vs surface roughness at DOC = 0.3 mm.

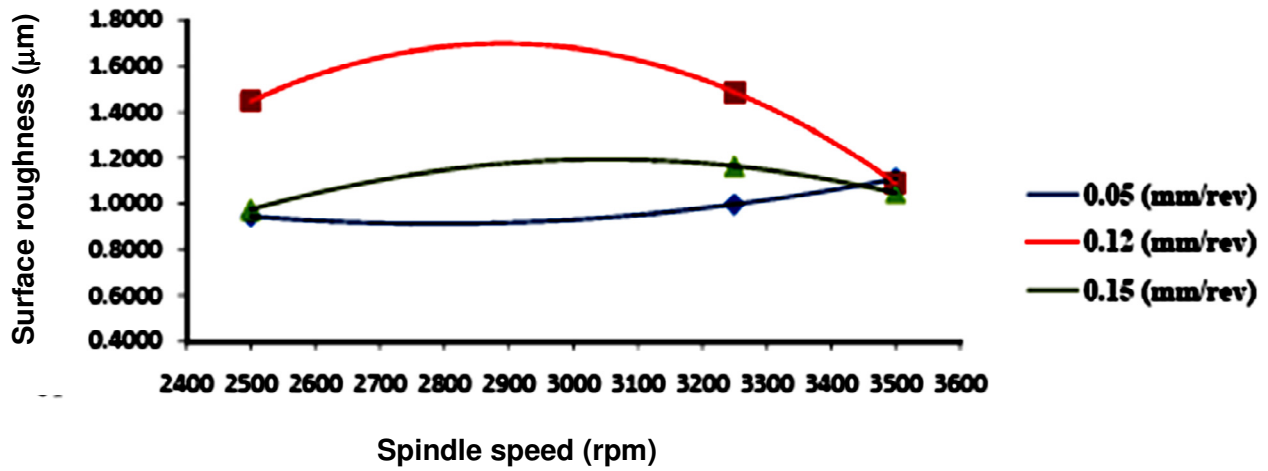

Figure 13. Spindle speed vs surface roughness at DOC = 0.4 mm.

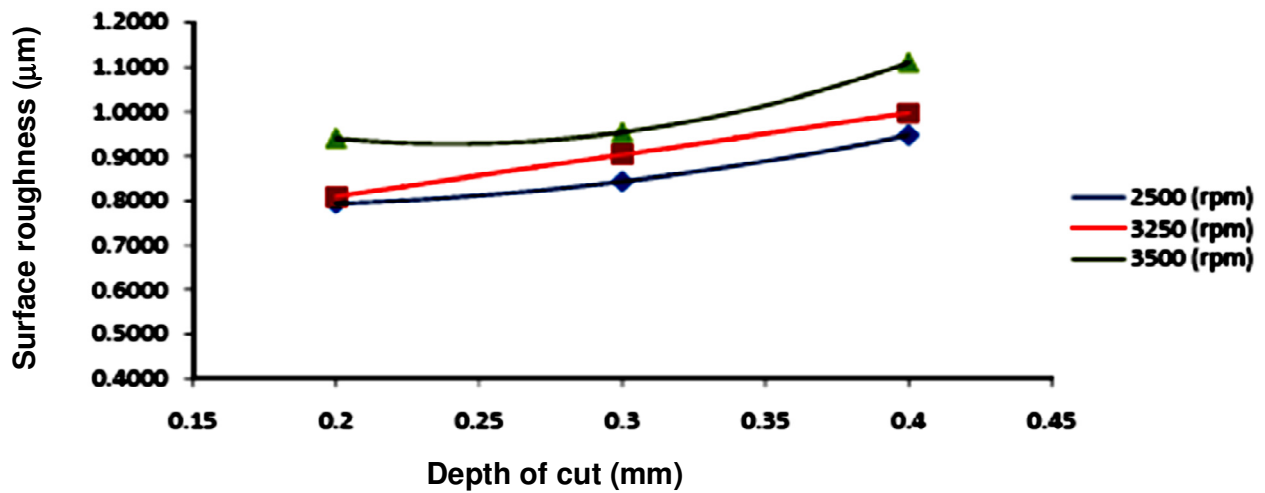

Figure 14. Depth of cut Vs Surface roughness at feed rate = 0.05 mm/rev.

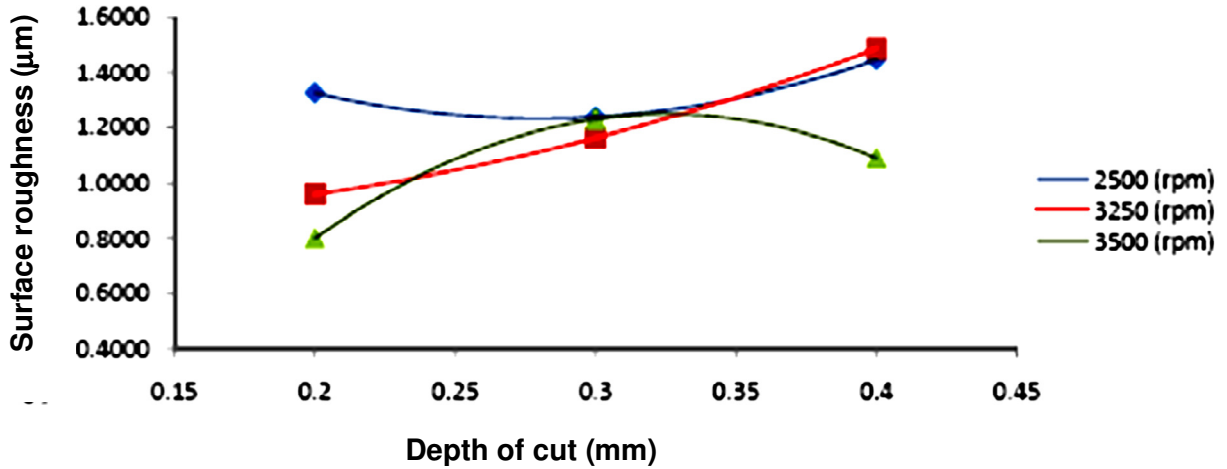

Figure 15. Depth of cut vs surface roughness at feed rate = 0.12 mm/rev.

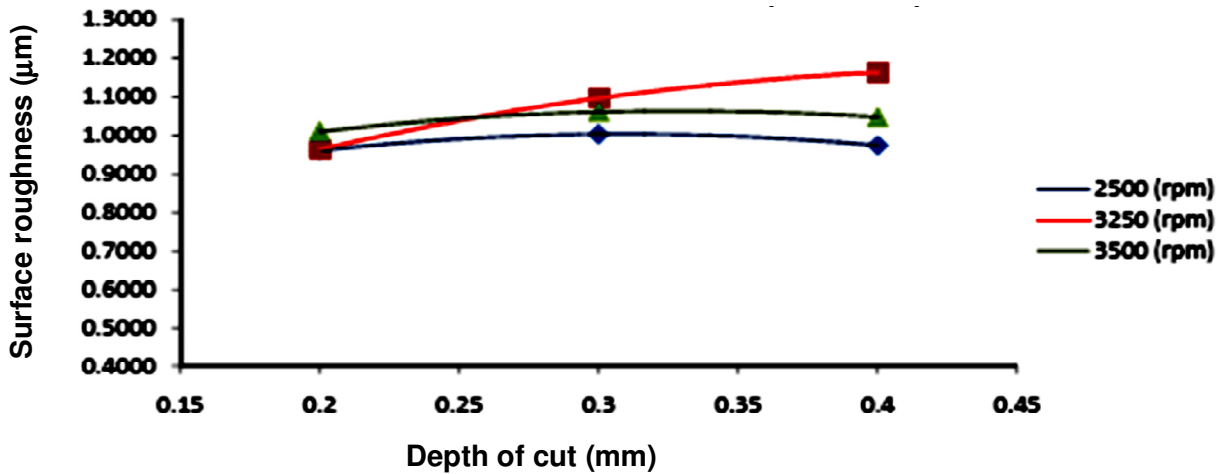

Figure 16. Depth of cut Vs surface roughness at feed rate = 0.15 mm/rev.

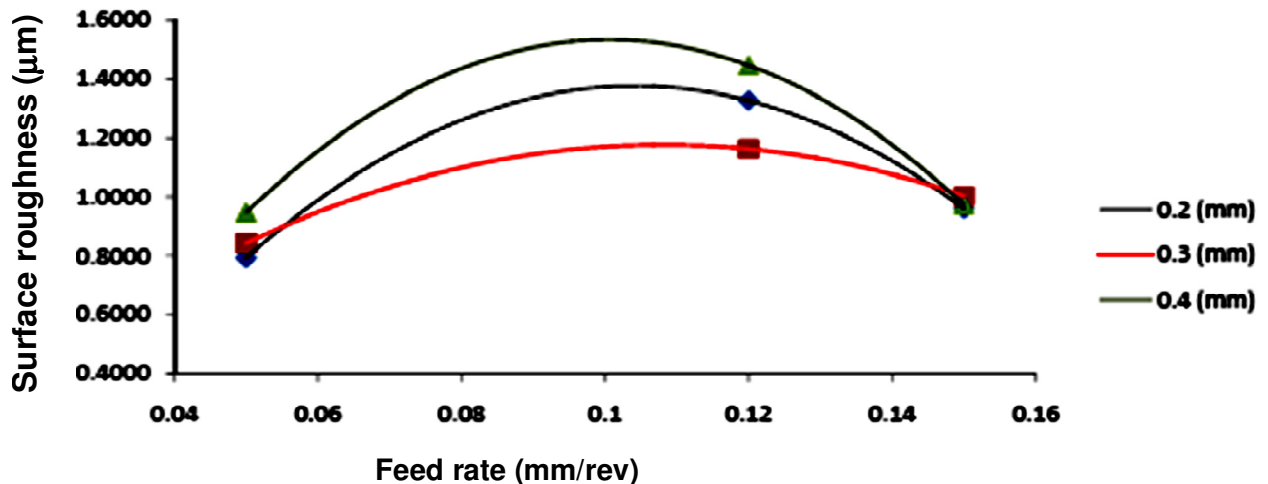

Figure 17. Feed rate vs surface roughness at spindle speed = 2500 rpm.

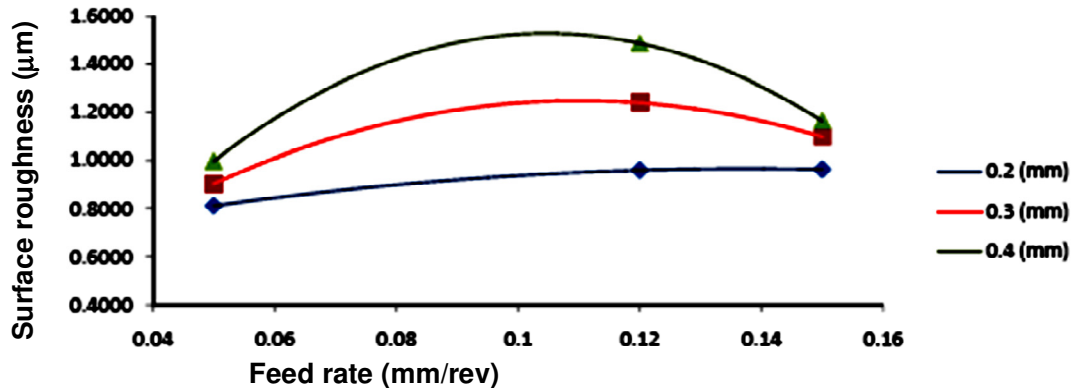

Figure 18. Feed rate vs surface roughness at spindle speed = 3250 rpm.

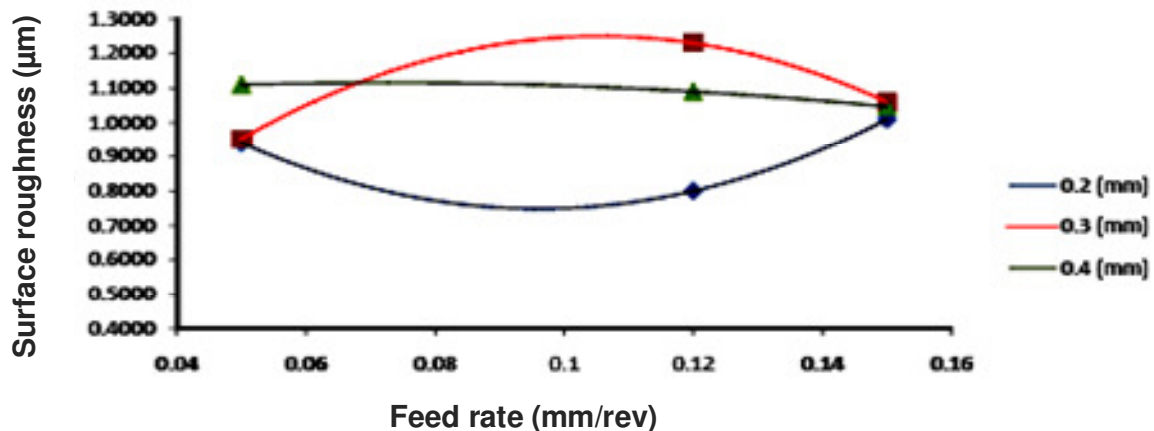

Figure 19. Feed rate vs surface roughness at spindle speed = 3500 rpm.

the surface roughness changes considerably.

6. As the depth of cut influences the surface roughness considerably for a given feed rate, the increase in feed rate causes the surface roughness to increase and then decrease. For lower depth of cut, as the feed rate increases surface roughness decreases and then increases.

## REFERENCES

- Al-Ahmari AMA (2007). Predictive machinability models for a selected hard material in turning operations. *J. Mat. Process. Technol.*, 190: 305-311.
- Avisekh B, Evgueni V, Bordatchev S, Kumar C (2009). On-line monitoring of surface roughness in turning operations with optoelectrical transducer. *Int. J. Manuf. Res.*, 4(1): 57-73.
- Azouzi R, Guillot M (1997). On-line prediction of surface finish and dimensional deviation in turning using neural network based sensor fusion. *Int. J. Mach. Tool Manuf.*, 37(9): 1201-1217.
- Bajic D, Lela B, Zivkovic D (2008). Modeling of machined surface roughness and optimization of cutting parameters in face milling, ISSN, 0543-5846.
- David V, Rubén M, Menéndez C, Rodríguez J, Alique R (2006). Neural networks and statistical based models for surface roughness prediction. *International Association Of Science and Technology for Development, Proceedings of the 25th IASTED international conference on Modeling, identification and control*, pp. 326-331.
- Feng C X, Hu ZJ (2001). A comparative study of the ideal and actual surface roughness in finish turning, pp????????????????
- Franci C, Joze B (2003). Optimization of cutting process by GA approach. *Robotics and Computer Integrated Manufacturing*, 19:113-121.
- Groover, Mikell (1996). *Fundamentals of Modern Manufacturing*. Prentice Hall, Upper Saddle River, NJ (now published by John Wiley & Sons, New York).
- Hossain MI, Amin AKM, Patwari AU (2008). Development of an artificial neural network algorithm for predicting the surface roughness in end milling of Inconel 718 alloy. *International Conference on Computer and Communication Engineering, ICCCE (2008)*, 13-15: 1321-1324.
- Huang L, Joseph C, Chen (2001). A Multiple Regression Model to Predict In-process Surface Roughness in Turning Operation Via Accelerometer. *J. Ind. Technol.*, 17(2): 1-8.
- Mike SL, Joseph C, Chen, Li M (1998). Surface roughness prediction for CNC End milling, materials and processes quality control manufacturing. *J. Ind. Technol.*, 15(1): (1999).
- Muammer N, Hasan G, lahsan T (2007). Comparison of regression and artificial neural network models for surface roughness prediction with the cutting parameters in CNC turning. *Modelling and Simulation in Engineering*, Hindawi Publishing Corp. New York, NY, United States, 3: 2.
- Oktem H, Erzurumlu T, Kurtaran H (2005). Application of response

- surface methodology in the optimization of cutting conditions for surface roughness. *J. Mat. Process. Technol.*, 170: 11-16.
- Sakir T, Süleyman N, Ismail S, Süleyman Y (2008). Prediction of surface roughness using artificial neural network in lathe. International Conference on Computer Systems and Technologies - CompSysTech'08.
- Srikanth T, Kamala V (2008). A Real Coded Genetic Algorithm for Optimization of Cutting Parameters in Turning. *IJCSNS Int. J. Comput. Sci. Netw. Secur.*, 8(6):189-193.
- Suresh PVS, Venkateswara RP, Deshmukh SG (2002). A genetic algorithmic approach for optimization of surface roughness prediction model. *Int. J. Mach. Tools Manuf.*, 42: 675-680.
- Uros Z, Franci C (2003). Optimization of cutting conditions during cutting by using neural networks. *Robot. Comput. Integr. Manuf.*, 19: 189-199.
- Yang WH, Tarn YS (1998). Design optimization of cutting parameters for turning operations based on the Taguchi method. *J. Mater. Process. Technol.*, 84: 122-129.